

Forticrete[®] stone

Confidence you can build on



Cast Stone dressings

Creating a tradition for
over 40 years



Contents

- 4 General specification
- 5 Quoins
- 6 Plinths
- 7 String courses
- 8 Cills
- 9 Heads
- 10 Window surrounds
- 11 Bullseyes and arches
- 12 Door surrounds
Porch surrounds
- 13 Corbels
- 14 Caplock coping system
- 15 Copings
- 16 Gable vents
Apex and kneelers
Name and datestones
Chimney copings
- 17 Pier caps
Spheres
- 18 Balustrades
- 19 Porticos



Introduction

Forticrete's Cast Stone manufacturing facilities have been replicating the traditions of natural stone in Britain since 1968.

Today, Forticrete's Cast Stone Dressings are a perfect example of advanced technology and time honoured craftsmanship working together in perfect harmony. The result is a wide range of cast stone products using a semi-dry or wet cast format, of unrivalled quality with no compromise to aesthetic appeal.

Naturally high grade

Forticrete's factories use controlled processing that ensures an accurate mix of the raw materials is produced.

Design freedom

Forticrete has the ability and experience to create purpose-made products to your precise specification.

Each piece of Forticrete Cast Stone is available in a choice of six standard colours that are intended to replicate the natural stones available throughout the UK.

In common with natural stone, Forticrete Dressings are through coloured.

Quality without compromise

Forticrete Cast Stone Dressings are manufactured to BS 1217:2008 and conform to the United Kingdom Cast Stone Association's technical specification.

All Forticrete Walling and Cast Stone manufacturing facilities are BSI registered and operate to the requirements of BS EN ISO 9001:2000 – the National and International standard for quality systems.

Design and technical advice are also offered and samples are promptly available. Simply contact the Forticrete Sales Office to discuss your requirements.

Colours

Bespoke Cast Stone dressings

This brochure details a comprehensive range of standard profiles. Additionally, in the majority of cases, Forticrete's skilled craftsmen can fulfil your design requirements for bespoke items and turn them into reality; the only limitation is that Forticrete must be able to de-mould and handle the units. The designs you have in mind may be inspired by classical architecture or more decorative styles. Unusual sizes, intricate or irregular shapes and precise matches for special colours, Forticrete's bespoke service offers you the maximum design freedom.

It's the ideal service whether you are including distinctive design touches in a new build project, blending seamlessly into a sensitive environment or undertaking restoration work.

Individual quotations for these items will be provided on receipt of instructions. In the rare instance that your bespoke designs are not achievable, Forticrete's experienced sales and technical team are able to suggest alternatives that will complement your original ideas.

When used in conjunction with a unique bespoke colour matching capability, Forticrete can fulfil your cast stone requirements irrespective of their complexity in colour and finish.

Bespoke colours

Forticrete has a library of over 400 Cast Stone colours that can be reproduced with accuracy at any time. Should you require a specific colour that is not in the catalogue, this can be provided at a supplementary cost.

Weathering resistance

All Forticrete Specification Masonry products are manufactured with water repellent additives which dramatically reduce both water absorption and penetration.

These additives are incorporated in the constituent mix and are therefore an inherent feature of the products even after cutting, splitting or texturing of the surface.

This improved ability to repel moisture greatly accelerates the drying process following inclement weather, thereby reducing the adhesion of atmospheric dirt particles which normally lead to unsightly staining.

An additional benefit during construction is a reduced initial suction of moisture from the joints, allowing improved curing of the mortar without any loss of adhesion.

Engraving service

Communication is a key requirement in today's world. Forticrete can offer you engraved cast stone units, which could be simple name stones or logos, or a combination of both. This instantly differentiates your building, making it immediately recognisable and unique.

General notes

All dimensions shown in this brochure are in millimetres. Stone to stone joints are nominally 5mm unless otherwise stated.

No provision will be made for fixings unless they have been specified or are stated in this brochure.

Any product sold will be sold subject to Forticrete's current terms and conditions of sale, which are available from its sales office.

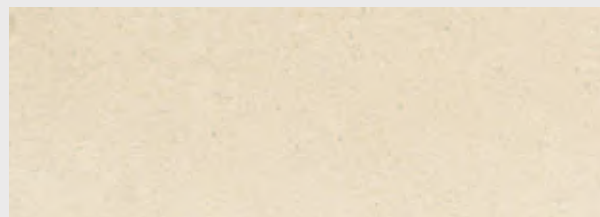

Portland



Bath

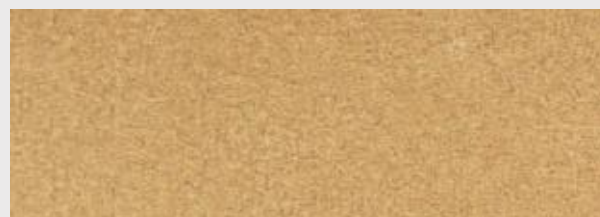

Buff

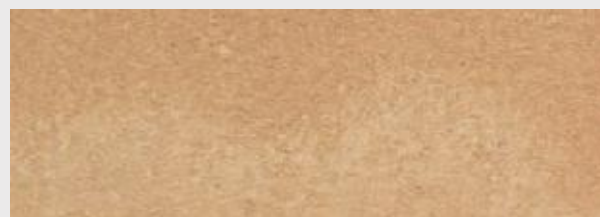

Holyrood



Glamis Red

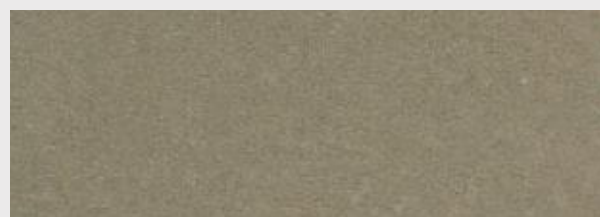

Sherwood

The reproduction of colour is as close as is possible within the photographic and printed processes. Where precise colour tolerances are vital, you are advised to view actual product samples.

Stone in Stock

A number of standard items are available from stock in the Bath colour. There is separate literature which details them in full.



General specifications

Forticrete Cast Stone Dressings are manufactured from high grade limestone and sandstone aggregates that have been chosen for their known performance and reliable quality. The cement, pigments and waterproofing agents all conform to their appropriate British or European Standard.

Forticrete Cast Stone Dressings are created from an homogeneous mix, without using

a 'backing' material. This ensures that no undue stresses are built up within the unit.

The major technical performance characteristics of Forticrete Cast Stone Dressings exceed the requirements of BS 1217 and the United Kingdom Cast Stone Association specification.

Compressive strength:

In accordance with the updated UKCSA recommendations, all Forticrete Cast Stone is now manufactured with a design compressive strength potential in excess of 35 MPa, (35 N/mm²) when reaching concrete maturity.

Density:

Typical Material Density = 2100Kg/m³

Thermal conductivity 'K' :

Exposed: 1.56 W/mK
Protected: 1.46 W/mK

Water Absorption (typical):

3.5%

Drying shrinkage:

Less than 0.04%

Dimensional tolerances cast stone

Unit Length	Tolerance
0-600mm	±2mm
601-1000mm	±3mm
1001-2500mm	±4mm
2501-4000mm	±5mm
>4000mm	±6mm

Mortar

Mortar used for the installation of Cast Stone Dressings should not be stronger than Designation III (1:1:5/6).

Handling reinforcement

Any units over 600mm in length contain one or more steel bars. These are included to comply with Health and Safety Regulations, relating to the handling of the product by site operatives.

Fixings for support, restraint and handling

Some Forticrete Cast Stone Dressings will incorporate 100mm stainless steel dovetail slots to restrain lateral movement in vertical units i.e. window jambs, door jambs etc. M16 sockets may also be used for handling purposes in the factory.

Structural properties

Unless otherwise agreed with Forticrete, all cast stone units are decorative and are not designed to be load bearing. The structural stability of all units in their finished state should be approved by the structural engineer carrying out the overall design for the project. Wind loading on large window features, sections of stonework, supporting lintels and fixings to cast stone units should also be considered early in the design process.

Due care and attention should also be given to the differential shrinkage and expansion rates between clay and cast stone units when employed in combination.

Site operatives must be made aware of the need to support and protect all cast stone units in their temporary state to negate the risk of any load being implied upon them whilst construction is taking place e.g. window heads.

Inserts and anchor slots can easily be incorporated into cast stone for restraint and for lifting at the request of the specifier/designer. However, if any unit is to be hoisted with more than one lifting socket, this should be carried out in conjunction with a spreader beam to eliminate any bending action of the unit. Forticrete may use lifting sockets to transport units at the source of manufacture. The use of such sockets on site should be checked with the factory of origin.

Forticrete are able to offer guidance on all areas of design and can be contacted via the telephone number on the back of this brochure.

Control joints

Consideration must be given to the creation of suitable movement control joints, full recommendations for which are given in the Forticrete Architectural Products Design Guide. Generally, control joints for Cast Stone should be spaced at a maximum of 6m centres.

Weathering

Weathering class: CAT to BS 1217 and UKCSA Specification.

Factors such as design, detailing, exposure, climate and local environment all contribute to the way in which Cast Stone will weather. Forticrete Cast Stone will weather in much the same way as natural stone in similar circumstances.

Regency™ Ashlar and Quoins

All quoins are externally faced. Please specify if internal quoins are required as an alternative. Some quoin units are handed. When ordering, please remember to specify the hand required.

Code	A	B	C	D	Weight (Kg)
A1	100	215	440	-	20
A2	100	290	440	-	27
A3	150	215	440	-	30
A4	150	290	440	-	40
A5	100	140	440	-	13
A60	100	220	445	-	20
Q1	100	215	295	150	16
Q2	100	215	330	215	20
Q3	100	290	440	215	34
Q4	100	140	295	150	10
Q5	100	215	440	215	25
Q7	100	140	440	215	16
RQ5*	125	215	465	245	34
Q12	150	215	440	215	34
Q14	150	290	440	215	46
Q60-90	100	220	445	220	26

Regency Ashlar

A1/A3

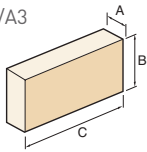

Plain Quoins

Q2/Q5

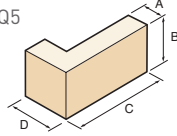

Code	A	B	C	D	Weight (Kg)
Q6	100	215	440	215	28
Q8	100	140	440	215	18
Q9	100	290	440	215	37
RQ6*	130	215	452	227	37
Q13	150	215	440	215	40
Q15	150	290	440	215	54
Q60-135	100	220	445	220	29

135° Plain Quoin

Q6-135

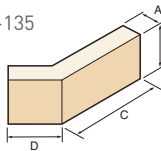

Code	A	B	C	D	E	Weight (Kg)
Q11	118	215	348	233	100	24
Q21	118	290	458	233	100	41
RQ11*	143	215	373	258	125	32

Chamfered Quoins

Q11

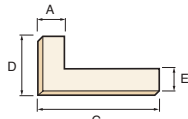
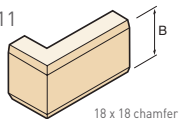

* Quoins 130mm on bed for use in conjunction with render
 - Denotes handed item left hand shown in all cases.



Code	A	B	C	D	Weight (Kg)
A1C	100	215	440	-	20
Q5C†	100	215	440	215	25

Regency Ashlar Chamfered & 90° Quoins

Code	A	B	C	D	Weight (Kg)
Q6C†	100	215	440	215	27

135° Chamfered Quoin

Code	A	B	C	D	Weight (Kg)
A1R	100	215	440	-	20
Q5R†	100	215	440	215	25
A60R	100	220	445	-	20
Q60R-90†	100	220	445	220	25

Regency Ashlar Rebated & 90° Quoins

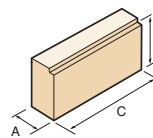

Rebate 20mm deep x 18mm high.

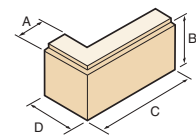

Code	A	B	C	D	Weight (Kg)
Q6R†	100	215	440	215	27
Q60R-135†	100	220	445	220	28

135° Rebated Quoin

Rebate 20mm deep x 18mm high.

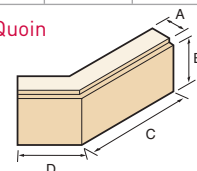



Plinths

Code	A	B	C	D	E	F	Weight (Kg)
PL1	150	140	890	50	50	90	37

PL1

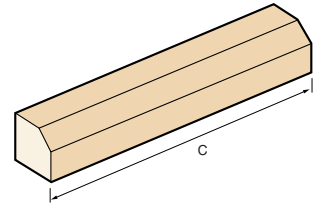
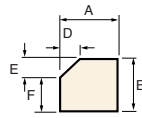

Code	A	B	C	D	E	F	Weight (Kg)
PL1-90E	150	140	215	50	50	90	12

PL1-90E

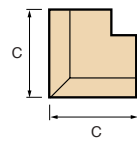
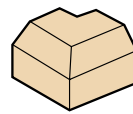

Code	A	B	C	D	E	F	Weight (Kg)
PL1-90INT	150	140	215	50	50	90	12

PL1-90INT

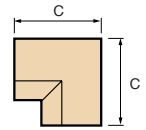
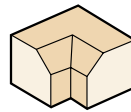

Code	A	B	C	D	E	F	Weight (Kg)
PL2	150	215	440	50	50	165	29
PL2-90E	150	215	215	50	50	165	18
PL2-90INT	150	215	215	50	50	165	18
PL2-135E	150	215	215	50	50	165	24
PL2-135INT	150	215	215	50	50	165	24

PL2

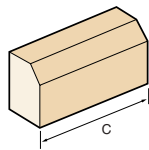
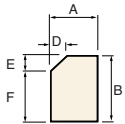

Code	A	B	C	D	E	F	Weight (Kg)
PL3	150	140	890	50	110	30	34
PL3-90E	150	140	215	50	110	30	11
PL3-90INT	150	140	215	50	110	30	11
PL3-135E	150	140	215	50	110	30	14
PL3-135INT	150	140	215	50	110	30	14

PL3

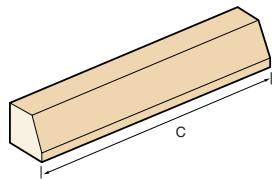
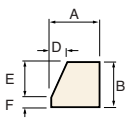

Code	A	B	C	D	E	F	Weight (Kg)
PL1-135E	150	140	215	50	50	90	15

PL1-135E

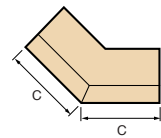
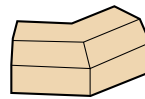

Code	A	B	C	D	E	F	Weight (Kg)
PL4	150	215	440	50	110	105	27
PL4-90E	150	215	215	50	110	105	18
PL4-90INT	150	215	215	50	110	105	18
PL4-135E	150	215	215	50	110	105	23
PL4-135INT	150	215	215	50	110	105	23

PL4

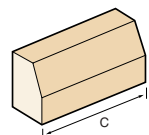
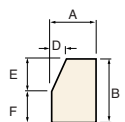

Code	A	B	C	D	E	F	Weight (Kg)
PL1-135INT	150	140	215	50	50	90	15

PL1-135INT

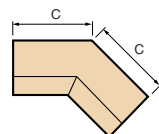
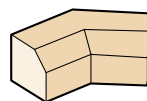

String Course

Code	A	B	C	D	E	F	Weight (Kg)
SC1	130	140	890	30	30	100	32

SC1

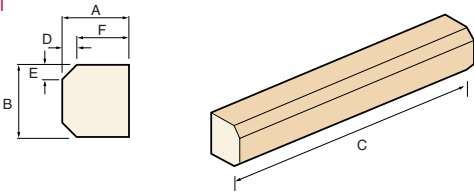

Code	A	B	C	D	E	F	Weight (Kg)
SC1-90E	130	140	245	30	30	100	13

SC1-90E

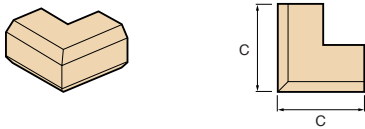

Code	A	B	C	D	E	F	Weight (Kg)
SC1-90INT	130	140	315	30	30	100	17

SC1-90INT

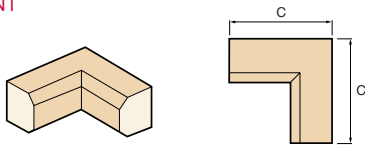

Code	A	B	C	D	E	F	Weight (Kg)
SC1-135E	130	140	227	30	30	100	14

SC1-135E

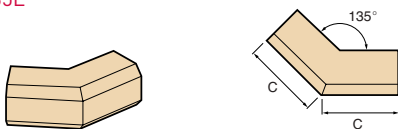

Code	A	B	C	D	E	F	Weight (Kg)
SC1-135INT	130	140	256	30	30	100	17

SC1-135INT

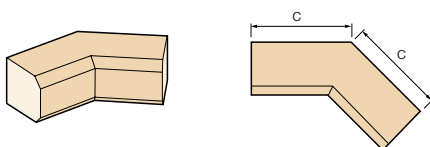

SC2

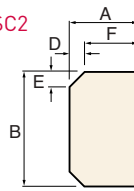

Code	A	B	C	D	E	F	Weight (Kg)
SC2	130	215	440	30	30	100	25
SC2-90E	130	215	245	30	30	100	20
SC2-90INT	130	215	315	30	30	100	29
SC2-135E	130	215	227	30	30	100	23
SC2-135INT	130	215	256	30	30	100	26

SC3

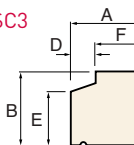

Profile applies to T1 & T11 cill units only (see page 8)

Code	A	B	C	D	E	F	Weight (Kg)
SC3	150	140	890	50	105	100	37
SC3-90E	150	140	265	50	105	100	15
SC3-90INT	150	140	315	50	105	100	20
SC3-135E	150	140	236	50	105	100	17
SC3-135INT	150	140	256	50	105	100	19

SC4

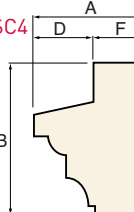

Code	A	B	C	D	F	Weight (Kg)
SC4	217	290	440	115	102	39
SC4-90E	217	290	330	115	102	34
SC4-90INT	217	290	318	115	102	42
SC4-135E	217	290	262	115	102	36
SC4-135INT	217	290	258	115	102	40

SC5

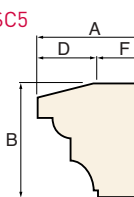

Code	A	B	C	D	F	Weight (Kg)
SC5	217	215	440	115	102	32
SC5-90E	217	215	330	115	102	28
SC5-90INT	217	215	318	115	102	34
SC5-135E	217	215	262	115	102	30
SC5-135INT	217	215	258	115	102	32

SC6

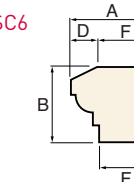

Can be used as label mould to window heads

Code	A	B	C	D	F	Weight (Kg)
SC6	157	140	890	55	102	34
SC6-90E	157	140	270	55	102	14
SC6-90INT	157	140	318	55	102	19
SC6-135E	157	140	238	55	102	15
SC6-135INT	157	140	258	55	102	18

SC7

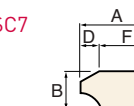

Can be used as label mould to window heads

Code	A	B	C	D	F	Weight (Kg)
SC7	140	70	890	40	100	16
SC7-90E	140	70	255	40	100	6
SC7-90INT	140	70	315	40	100	9
SC7-135E	140	70	232	40	100	7
SC7-135INT	140	70	256	40	100	8



Stooled cills are built in at the time of construction.

They should be bedded under the stooling only at the time of installation with an inert packer in the centre. The cill should be solidly pointed as the scaffold is taken down upon completion of the construction.

Code	A	B	C	D	E*	F	Max Length	Kg Per Lin/M
T1-40	150	140	105	40	102.5/140	100	1547	39
BN1	150	140		65	102.5/140	100	1547	39
T2	150	65	40	65	102.5/140	100	1000	17
T3	200	140	105	65	102.5/140	150	1547	53
T4-40†	175	140	105	40	102.5/140	125	1547	46

Stooled Cill

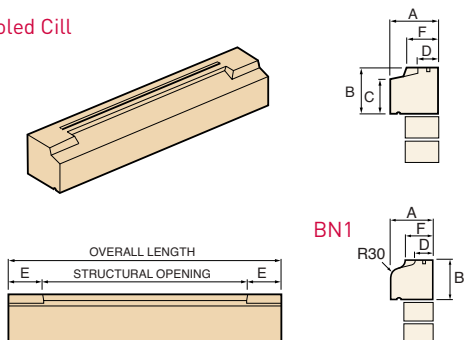

Code	A	B	C	D	E*	F	G	Max Length	Kg Per Lin/M
ST6	215	140	105	65	102.5/140	165	18	1547	56
ST7	215	65	40	65	102.5/140	165	18	1000	24
ST8=	245	140	105	65	102.5/140	195	18	1547	63

Chamfered Stooled Cill

(Designed to close cavity)

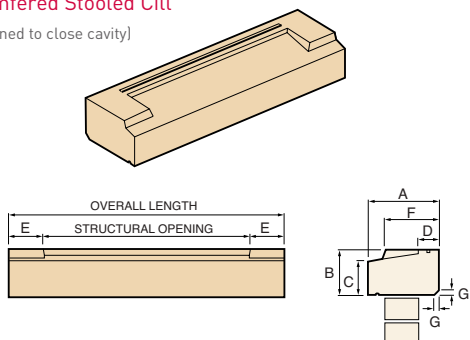

* Specify on ordering
† Designed for use with render

Cills

Cills are manufactured in accordance with BS 5642.

Cills of greater length than those shown in the tables are available and are made in more than one piece.

Code	A	B	C	D	Max Length	Kg Per Lin/M
T11-40	150	140	105	40	1547	39
BN11	150	140	-	65	1547	39
T12	150	65	40	65	1000	17

Slip Cill

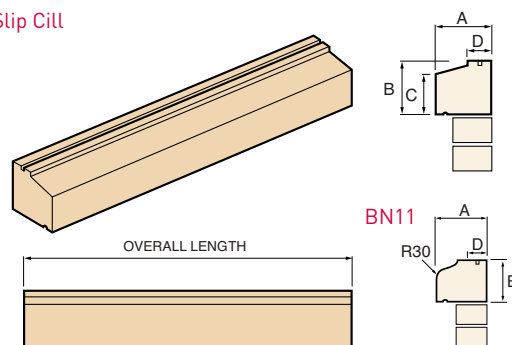

Code	A	B	C	D	E	Max Length	Kg Per Lin/M
SC10	215	140	105	65	18	1547	55
SC11	215	65	40	65	18	1000	22
SC12†	245	140	105	65	18	1547	62

Chamfered Slip Cill

(Designed to close cavity)

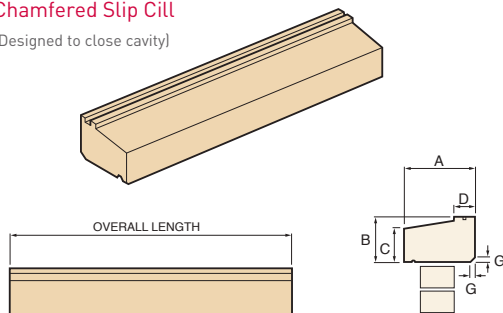

Slip Cills forming 90° at Bay

Code	A	Kg
T11-40-90E	265	15
BN11-90E	265	15

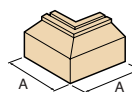

90° Slip Cill

Available to suit any standard or special section, please specify cill type and external dimensions of brickwork. Purpose-made products are available on request.

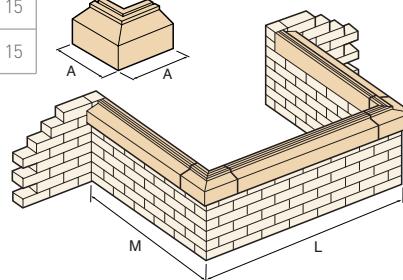

Slip Cills forming 45° at Bay

Code	A	Kg
T11-40-135E	236	16
BN11-135E	236	16

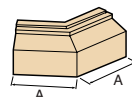

135° Slip Cill

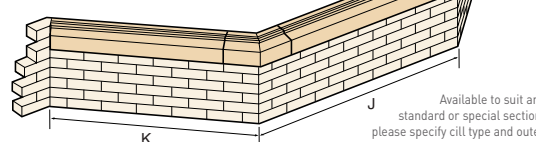

Available to suit any standard or special section, please specify cill type and outer dimension of brickwork. Purpose-made products are available on request.

Structural Heads

These units contain a post-tensioned stainless steel element. They will support loads as indicated in the table. It is essential that this load is in one direction and that the head is laid so that the orientation is correct.

Additional Requirements:

- 1 The maximum lengths shown cannot be exceeded.
- 2 Structural Heads cannot be CUT, GROUND, DRILLED or CHASED under any circumstances. Please advise of special requirements at the time of ordering as these may be accommodated in the casting process.
- 3 Structural Heads must be installed with the top uppermost.
- 4 Adequate bearing should be provided.

Please allow an extra 2 weeks for Structural Heads above standard availability for full curing to take place.

Code	A	B	Max UDL†	Max Length	Kg Per Lin/M
SH1	100	140	5	1547	29
SH2	100	215	7	2500	46
SH5	100	290	7	2500	61

Rectangular Structural Head

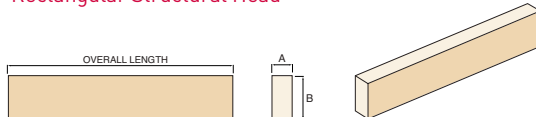

† Maximum uniformly distributed load

Code	A	B	C	D	Max UDL†	Max Length	Kg Per Lin/M
SH3	100	140	102.5/140	18	5	1547	29
SH4	100	215	102.5/140	18	7	2500	46
SH6	100	290	102.5/140	18	7	2500	61

Chamfered Structural Head

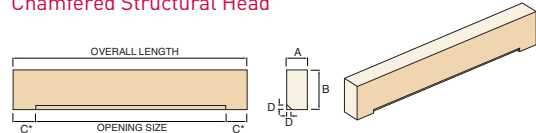

† Maximum uniformly distributed load

Code	A	B	C	D	E	F	Weight (Kg)
K1	265	215	165	150	65	18	9
K2	305	290	165	150	65	18	13
K3	346	365	165	150	65	18	16

Cosmetic Keystone K1/2/3

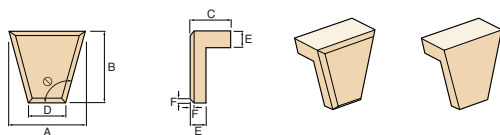

Degree angle $\odot = 105^\circ$ to match Splayed Heads
If chamfered Keystone is required please pre-fix with C



Decorative Heads

Although these heads are decorative, they will carry a uniformly distributed load of 3 KN over a clear span of 1 metre provided there is adequate bearing, with a minimum section of 140mm high x 100mm wide. Spans greater than 1 metre should have the appropriate supporting or relieving lintel.

Decorative Heads of greater length than those shown in the tables are available and are made in pieces.

Code	A	B	Max Length	Kg Per Lin/M
DH1	100	140	1547	29
DH2	100	215	2500	46
DH5	100	290	2500	61

Rectangular Head

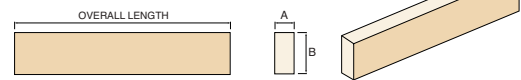

Code	A	B	C	D	Max Length	Kg Per Lin/M
DH3	100	140	102.5/140	18	1547	29
DH4	100	215	102.5/140	18	2500	46
DH6	100	290	102.5/140	-	2500	61

Chamfered Head

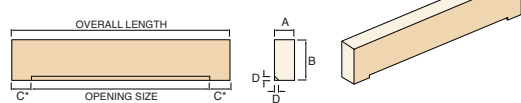

Code	A	B	C	Max Length	Kg Per Lin/M
DH11	100	215	58	2500	45
DH12	100	290	78	2500	61

Splayed Head

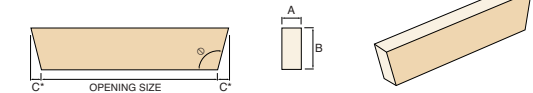

Code	A	B	C	D	F	Weight (Kg)
K4	265	215	130	150	18	12
K5	305	290	130	150	18	18
K6	346	365	130	150	18	24

Keystone K4/5/6

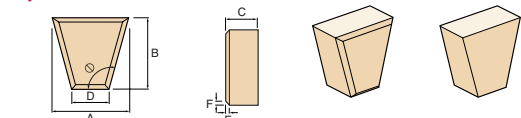



Window Surrounds

Jamb will have 100mm s/s dovetail anchor slots where they exceed 450mm in length. No window head should exceed 1 metre clear span without support. No fixings or allowance will be made for the interconnection of head, mullion, cill and jamb unless specified. Please specify if surrounds are to be finished internally.

Label

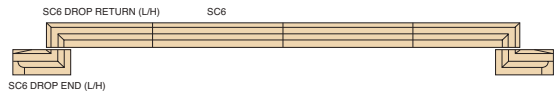

Alternative label suitable for each profile. Refer to page 7 for details.

A	B	C	D	E	F	G	H
190	140	70	75	See table below	140	118	48

Wensley

Label type SC7 refer to page 7 for details

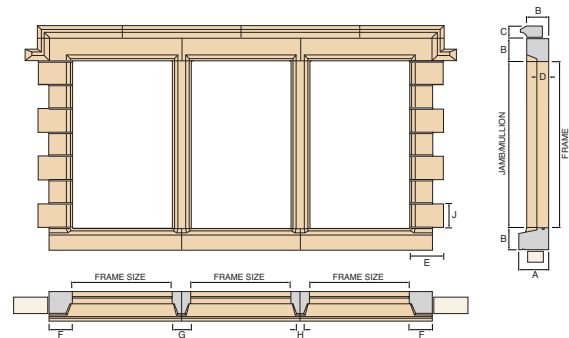

Jamb Blocks

E	140	215	140	215	140	215
J	140	140	215	215	290	290
Kg Per Unit	6	9	9	14	12	19

A	B	C	D	E	F	G	H
190	140	70	75	128	140	118	94

Darley

Label type SC7 refer to page 7 for details

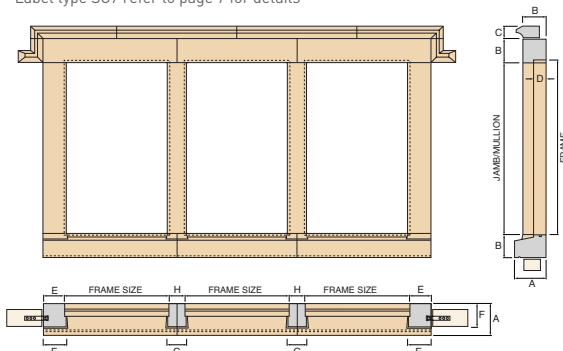

S/S Anchor slots cast in jambs at a maximum of 450mm centres

A	B	C	D	E	F	G	H
190	140	70	75	128	140	118	94

Derwent

Label type SC7 refer to page 7 for details

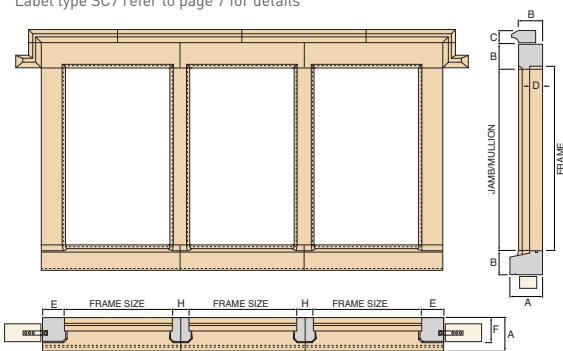

S/S Anchor slots cast in jambs at a maximum of 450mm centres

Note: If the Darley or Derwent surrounds are required to course with adjacent brickwork, the window frames should be 22mm higher than standard, i.e. A 1050mm high frame would need to be 1072mm to allow for 2 no. 5mm joints and a 12mm rebate.

Code	Kg Per Lin/M
CILL (overhanging)	52
CILL (flush)	41
JAMB	41
MULLION	35
HEAD	41
SC6	38
SC7	18

A	B	C	D	E	F	G	H
190	140	70	75	105	140	118	48

Winstler

Label type SC7 refer to page 7 for details

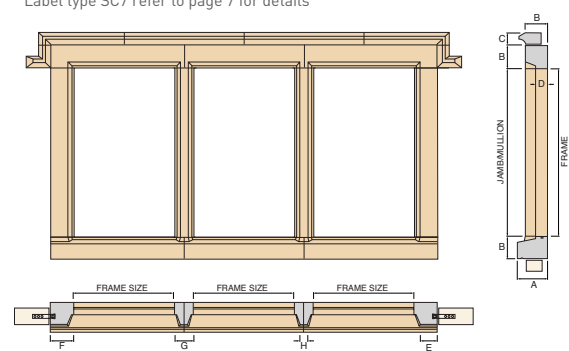

S/S Anchor slots cast in jambs at a maximum of 450mm centres

Note: If the Wensley or Winstler surrounds are required to course with adjacent brickwork, the window frames should be 10mm higher than standard, i.e. A 1050mm high frame would need to be 1060mm. This is due to the fact that ordinary masonry frames are smaller in height by 10mm to allow for the structural lintel to sit in-between the frame and masonry. When using stone heads the structural lintel is ideally placed above the self supporting head.

Code	Kg Per Lin/M
CILL (overhanging)	52
CILL (flush)	41
JAMB	41
MULLION	35
HEAD	41
SC6	38
SC7	18

Arched Surrounds

Code	A	B	C	D	E	F	R	Weight (Kg)
AC1	1345	140	150	215	-	-	-	53
AJ1	-	-	-	215	290	100	-	13
AH1	-	-	-	215	-	100	458	27

Arched Surround 915

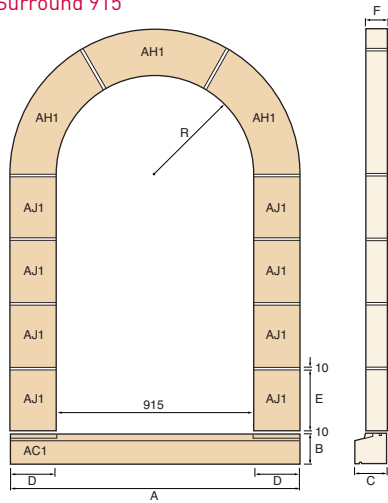

Code	A	B	C	D	E	F	R	Weight (Kg)
AC4	1630	140	150	215	-	-	-	64
AJ1	-	-	-	215	290	100	-	13
AH2	-	-	-	215	-	100	600	33

Arched Surround 1200

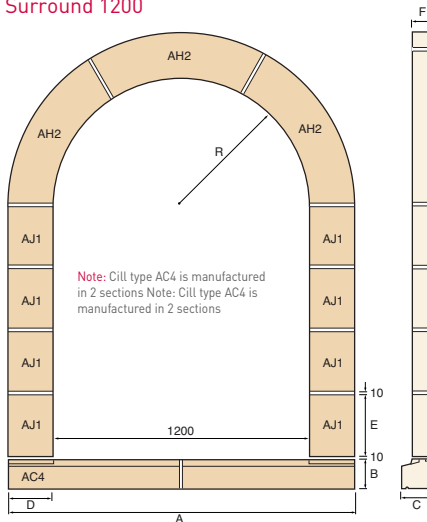

Code	A	B	C	D	E	F	Weight (Kg)
JH1-A1	1050	140	50	100	150	375	30
JH1-A2	1200	140	50	100	150	450	35
JH1-B1	1050	100	50	140	150	375	30
JH1-B2	1200	100	50	140	150	450	35

Jambs

JH1-A

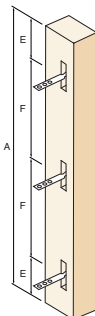

JH1-B



Bullseye Window Surrounds

Bullseye window surrounds are supplied in sections with an allowance for 5mm mortar joints.

Code	A	B	C	D	F	Weight (Kg)
BU1	140	140	105	75	600	90

Bullseye Window Surround

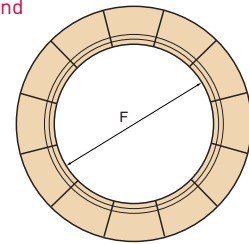
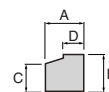

Code	A	B	C	D	E	F	Weight (Kg)
BU2	140	140	135	75	30	600	98

Bullseye Window Surround with Keystones

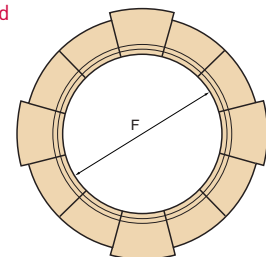
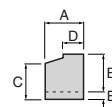

Code	A	B	F	Weight (Kg)
BU3	100	215	915	158
BU4	100	215	1200	198

Plain Bullseye Window Surround

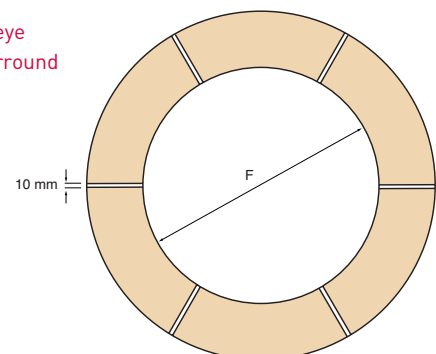



Door Surrounds

Door heads with a span in excess of 1 metre should have a support or relieving lintel with the appropriate joint between head and lintel.

Door jambs will have 100mm Stainless Steel dovetail slots at 450mm centres. These are positioned in the 100mm face adjacent to the Masonry opening.

Label Mould (option)

Refer to page 7 for details

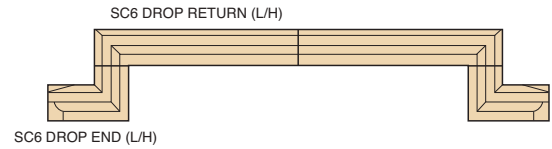

Porch Surrounds

Code	Span	A	B	C	D	E	F	Kg Per Unit
PSH1	1650	2306	365	-	-	-	-	385
PSH3	1810	2466	365	-	-	-	-	408
PJ1	-	-	-	295	-	328	280	51
PJ2	-	-	-	295	215	-	280	33
PJ3	-	-	-	295	-	328	280	51

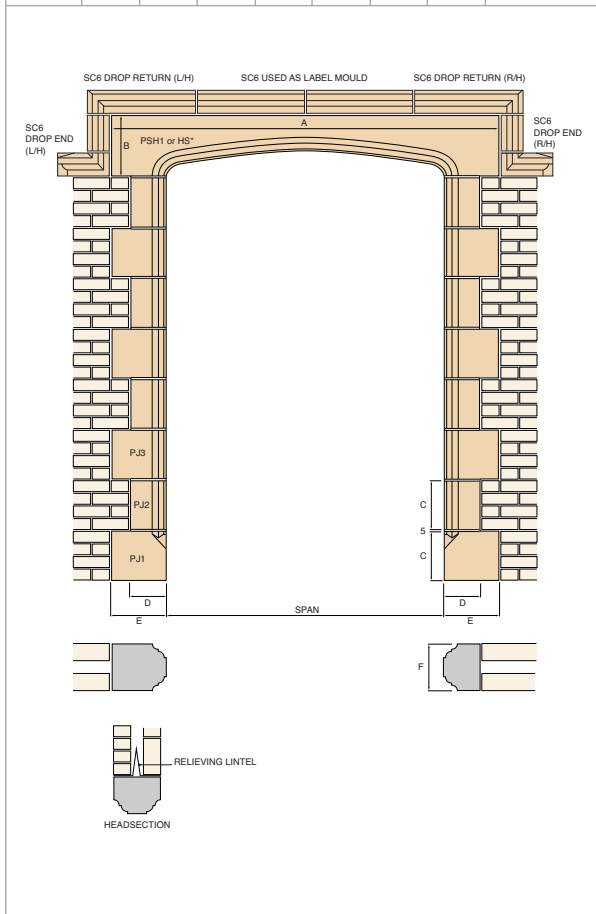

*Decorative head to be used in conjunction with a suitable relieving lintel.

Code	A	B	C	D	E	F	G	Weight (Lin Metre)
DS1w	100	215	70	215	1025	2095	300	43
DS2	100	215	70	215	1800	2095	300	43
DS3	100	215	70	215	2400	2095	300	43
SC6	158	-	140	-	-	-	-	38
SC7	140	-	70	-	-	-	-	18

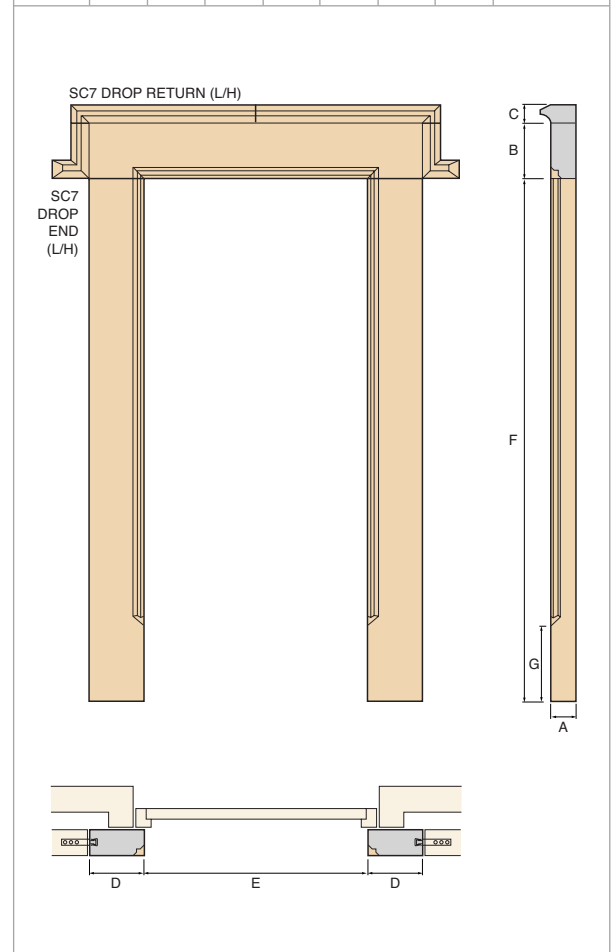

Corbels

Some corbels are handed. When ordering, please specify the hand required when viewing the gable elevation as shown in the adjacent photograph.

Code	A	B	C	D	E	F	Weight (Kg)
C4	100	215	180	665	445	-	29
C5	215	215	180	665	445	105	45
C6	100	140	105	665	445	-	19
C7	215	140	105	665	445	105	29

Angle Corbel

C4/6

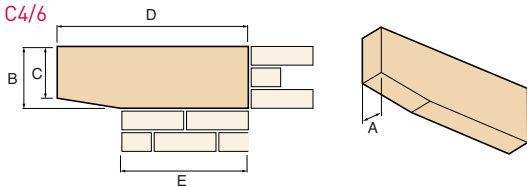

C5/7 (L)

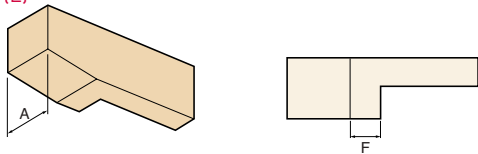

Left hand shown

Code	A	B	C	D	E	F	Weight (Kg)
C8	100	140	50	665	515	-	18
C9	215	140	50	665	515	175	28

Ogee Corbel

C8

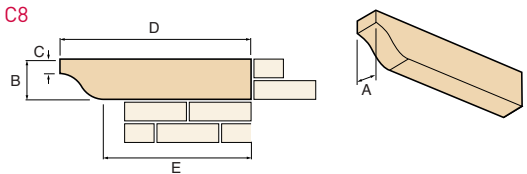

C9 (L)

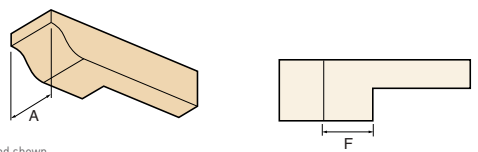

Left hand shown

Code	A	B	C	D	E	F	Weight (Kg)
C13	100	215	90	665	460	-	27

Moulded Corbel

C13

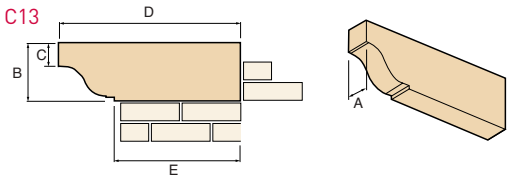

C14 (L)

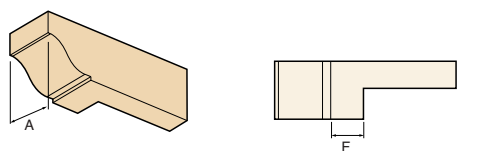

Left hand shown



Non-standard corbels can be made to suit specific requirements

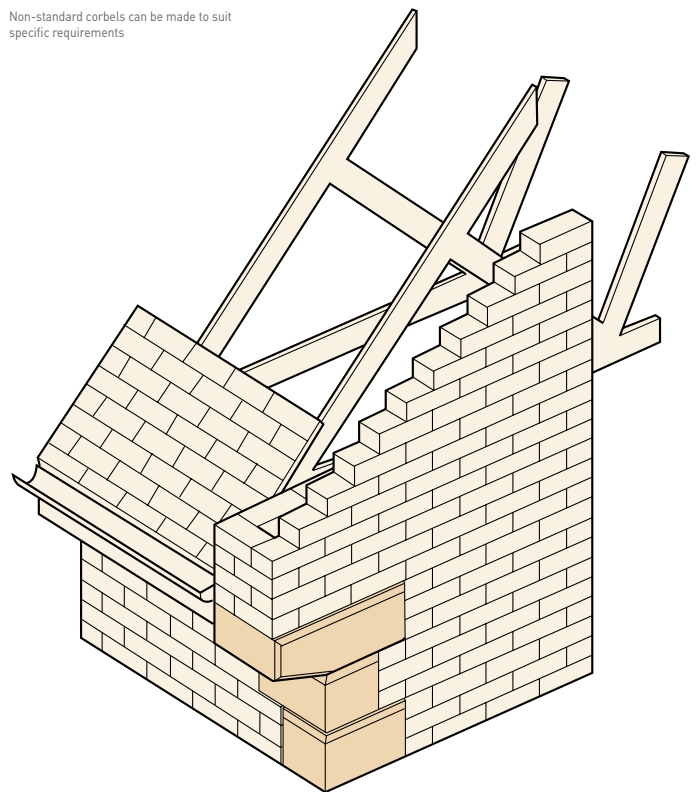

Code	A	B	C	D	E	F	Weight (Kg)
C10	233	215	153	555	330	100	43

Chamfered Corbel

(To match Q11 or Q21 quoins)

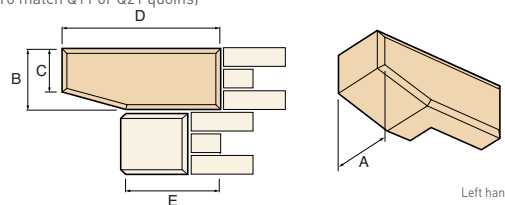

Left hand shown

C10 (L)

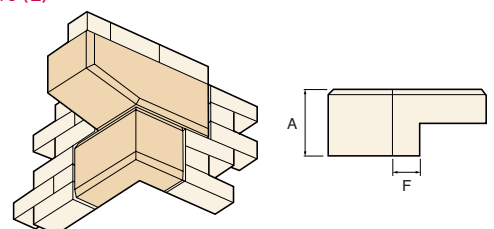



Caplock® Coping System

The Caplock® System locks together the top course of brickwork over a two metre length, forming a virtually immovable monolithic mass. This has great advantages. It adds security to parapet walls, boundary walls where vandalism may be a problem, and consequently can reduce lifetime maintenance costs. Each order is supplied with the correct amount of plastic 'locking' insert. Each component is available in wet cast or semi-dry formats, please specify the mix requirement when ordering.

Twice Weathered Caplock®

TWC-305

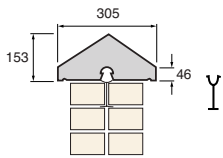

Caplock® insert foot dimension = 90mm

Code	Kg Per Unit	
	Wetcast	Semi-dry
TWC-305	66	57
TWC- L/H	44	38
TWC- R/H	44	38
TWC-STOP	44	38
TWC-FAIR	44	38
TWC-TEE	44	38

TWC-305

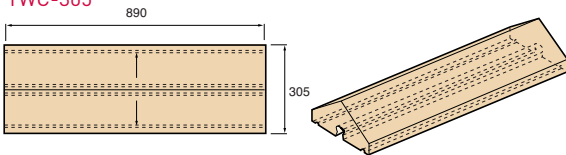

TWC-L/H R/H

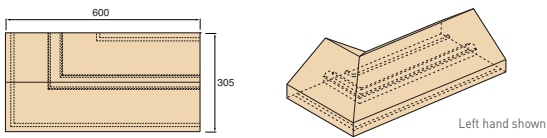

TWC-STOP

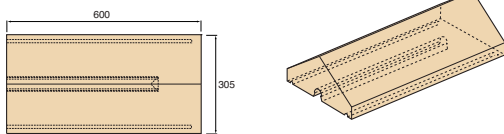

TWC-FAIR

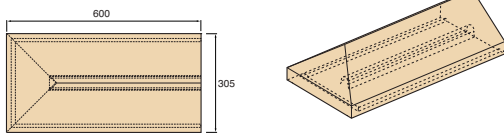

TWC-TEE

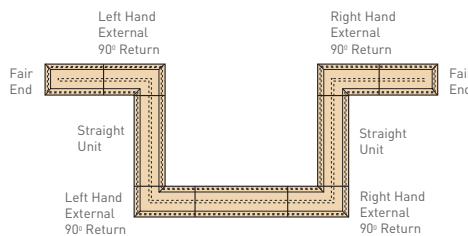
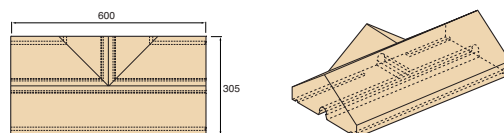

Double Cant Caplock®

DCC-305

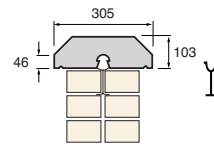

Caplock® insert foot dimension = 90mm

Code	Kg Per Unit	
	Wetcast	Semi-dry
DCC-305	61	54
DCC- L/H	41	36
DCC- R/H	41	36
DCC-STOP	41	36
DCC-FAIR	41	36
DCC-TEE	41	36

DCC-305

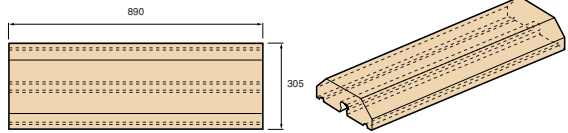

DCC-2 L/H R/H

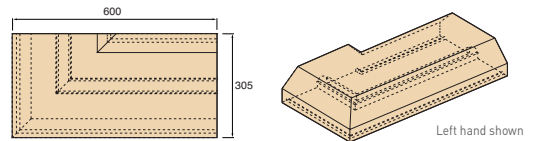

DCC-STOP

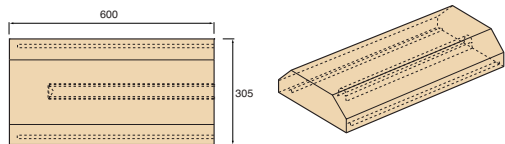

DCC-FAIR

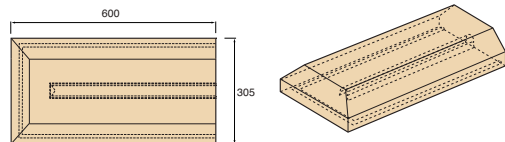

DCC-TEE

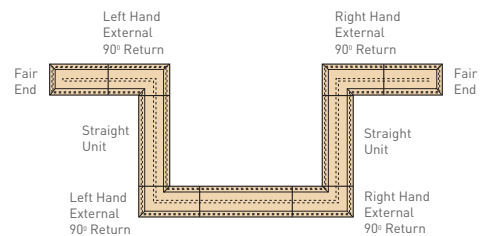
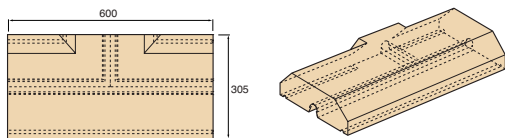

Copings

Forticrete's Customer Service is available for parapet design and technical advice. Suggested minimum overhang: 45mm. All copings are manufactured with a drip groove.



Code	Kg Per Unit
FC200	19
FC315	29
FC380	36

Flat Copings

L/H R/H Return

T-Junction

Stop End

Code	Kg Per Unit
OW200	23
OW315	37
OW380	44

One Weathered Copings

L/H R/H External Return

L/H R/H Internal

Stop End

Code	Kg Per Unit
TW200	23
TW315	37
TW380	44

Twice Weathered Copings

Universal Return

Fair End

T-Junction



Gable Vent

The rear of the gable vent is indented to accept a mesh barrier.

Code	A	B	C	D	Vent Area	Weight (Kg)
GV1	590	120	327	50	15,650mm ²	42
GV2	740	120	215	45	25,650mm ²	33
GF1	590	120	327	50	-	43
GF2	740	120	215	45	-	35

GV1/2

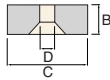
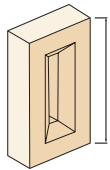

GF1/2

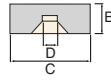
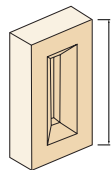

Name and Datestones

Code	A	B	C	Weight (Kg)
NS1	365	100	550	39
NS2	290	100	440	27
NS3	365	100	665	51

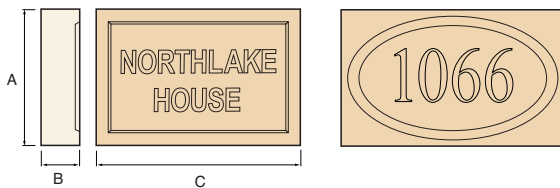

Standard letters - 65mm high (Sharp faced Gothic) Standard numerals - 125mm high (Times New Roman)

Medallion

Code	A	B	C
NS5	75	580	42

The 'Medallion' name plate may be used in conjunction with the 600mm Bullseye window surround.

Apex

Code	A	B	C	D	E	F	M
AS1	338	380	116	300	183	46	22.5o
AS2	350	380	144	300	202	43	30o
AS3	371	380	221	300	262	35	45

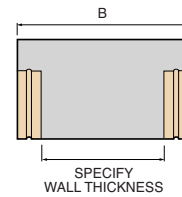
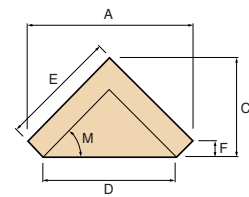

Kneelers

Code	A	B	C	D	E	F	G	H	J	K	L	M
KB1	328	380	247	378	140	107	75	50	50	44	116	22.50
KB2	440	380	344	501	215	129	75	50	50	74	149	300
KB3	440	380	400	460	215	185	75	50	50	185	262	450

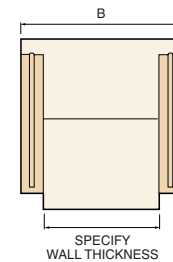
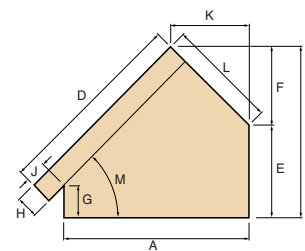

Chimney Coping

Code	A	B	C	D	Weight (Kg)
CP1	120	150	1000	100	132

CP1

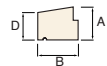
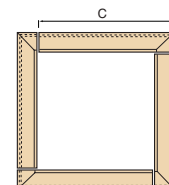
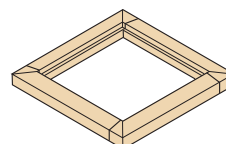

Pier Caps

Code	A	B	C	Pier Size	Weight (Kg)
PC1	125	315	75	215 x 215	19
PC2	125	425	75	327 x 327	35
PC3	140	540	75	440 x 440	59
PC4	140	650	75	552 x 552	86
PC5	140	765	75	665 x 665	119

Apex Pier Caps

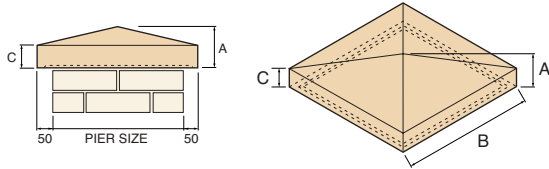

Spheres

Code	DIM B	Diameter	Use with cap ref	Weight (Kg)
S1	120	228	PD1, PD2	14
S2	150	305	PD3, PD4, PD5	32
S3	150	380	PD3, PD4, PD5	61

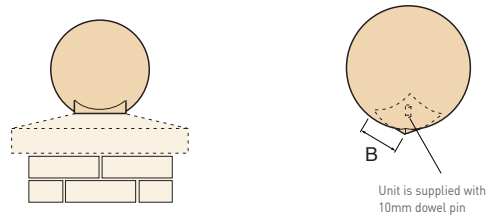

Cored Pier Caps

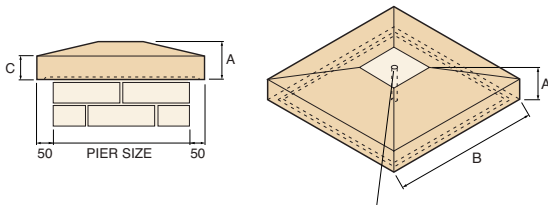

Stooled to suit sphere base

Code	Use with cap ref	A	B	Pier Size	Weight (Kg)
PB 3	PC3/PD3	70	520	440 x 440	39
PB 4	PC4/PD4	70	632	552 x 552	58
PB 5	PC5/PD5	70	745	665 x 665	80

Pier Caps Base

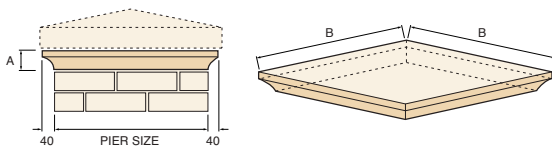



Balustrades

Forticrete's Balustrade system comprises a combination of precision components to enable you to create balustrades to meet your specific requirements.

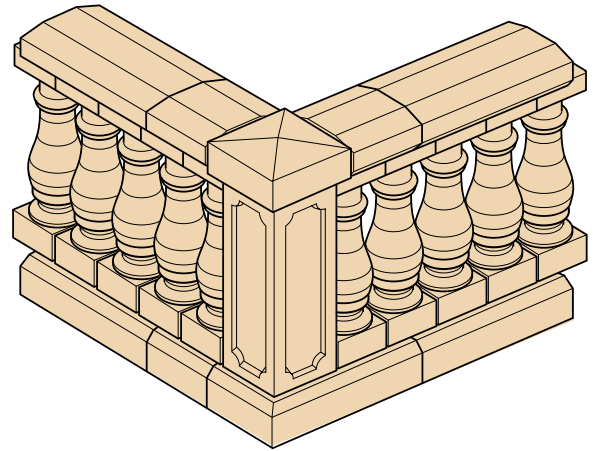

Code	A	B	C	Weight (Kg)
PS40	150	665	350	71

PS40

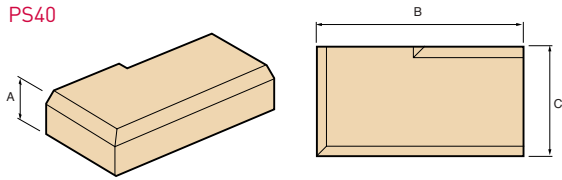

Code	A	B	C	Weight (Kg)
PS40	150	665	350	71

PS41

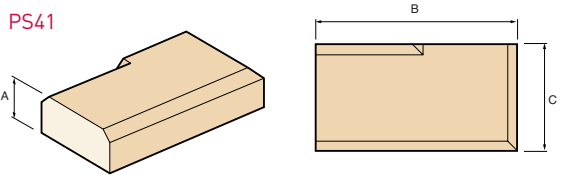

Code	A	B	C	Weight (Kg)
PS40	150	665	350	56

PS42

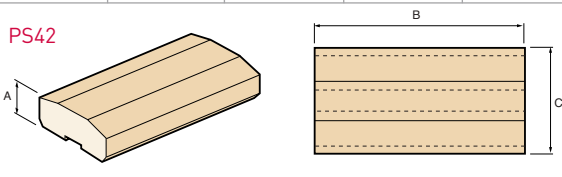

Code	A	B	C	Weight (Kg)
PS40	150	665	350	71

PS43

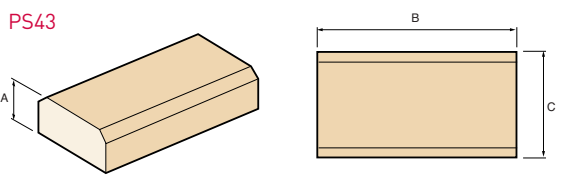

Code	A	B	Weight (Kg)
PS28	750	275	103

PS28

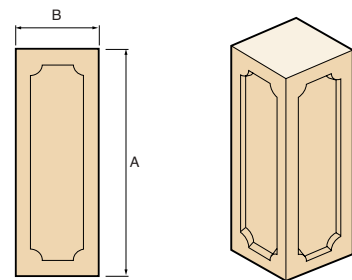

Code	A	B	Weight (Kg)
PS29	750	215	40

PS29

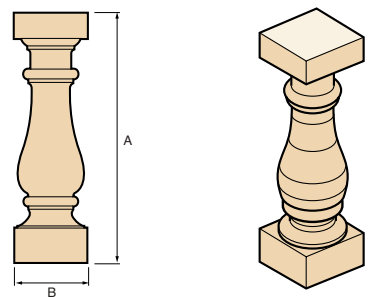

Code	A	B	Weight (Kg)
PS30	150	350	34

PS30

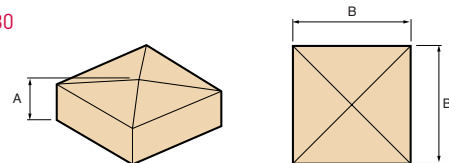

Standard Portico Kits

Forticrete can offer six standard Porticos; these are in three widths as shown in the table. Porticos 1 to 3 are without balustrades. It is only necessary for you to specify:

1. Portico number (type)
2. Dimension 'D'
3. The colour

The portico will be supplied shrink-wrapped on pallets and will contain all the necessary components. A full set of constructional and component drawings will be provided on receipt of your order.

The inside face of the structural ring beam has a series of threaded sockets along its length allowing you to install your own choice of decking or roof to the enclosed portico area.

All Portico kits allow for side wheelchair access.

Code	A	B	C	D (Max)	E (Max)
Portico Kit 1w	1730	1735	2390	3180	3855
Portico Kit 1w+HC	1730	1735	2390	3180	3855
Portico Kit 2w	2380	1735	3040	3180	3855
Portico Kit 2w+HC	2380	1735	3040	3180	3855
Portico Kit 3w	3030	1735	3690	3180	3855
Portico Kit 3w+HC	3030	1735	3690	3180	3855

Portico 1, 2, 3 without Balustrades

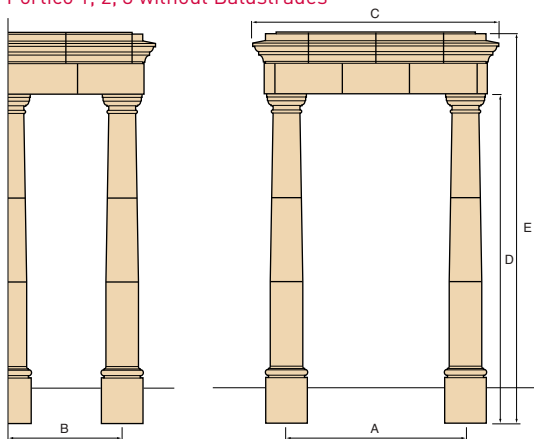

Note: Porticos 1 and 2 have 2 columns. Portico 3 has 4 columns.
 'w' Refers to wheelchair access. 'HC' refers to half columns.

Portico with Balustrades

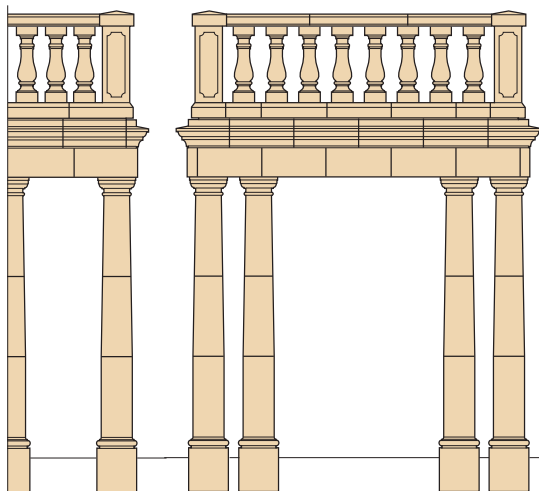

Please refer to Forticrete for advice



Standard Column Components

Code	A	B	C	Weight (Kg)
P0.3.1	382	280	180	36

Capitol

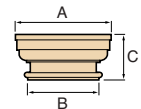
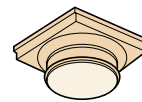

Code	A	B	C	Weight (Kg)
P0.5.1	260	285	800	98
P0.5.2	285	310	800	117
P0.5.3	310	310	*	127

Column

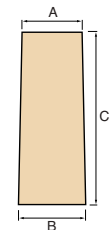

*Height can be adjusted from a maximum of 800mm

Code	A	B	C	Weight (Kg)
P0.4.1	310	400	100	22

Column Base

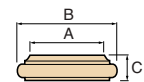

Code	A	C	Weight (Kg)
P0.4.2	400	*	148

Pedestal

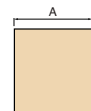
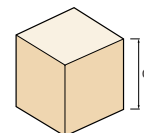

*Height can be adjusted from a maximum of 440mm

Complementary products for detailing, roofing & landscaping



Anstone® Brown Old Weathered Pitched and Cast Stone dressings in Bath at Whitehouse Loan, Edinburgh.

Anstone® and Shearstone™ walling stone

Forticrete Walling Stone has a history that cannot be replicated by any manufacturer in the UK, having provided a cost-effective, readily available alternative to natural stone since 1926. Today, it provides a unique, single-source solution to recreating the tradition of Britain's most enduring architectural heritage.

Tel: 01909 775000 Fax: 01909 773549
E-mail: walling@forticrete.com



Ember Hardrow Slates Duets® on Charles Church Homes, Staynor, near Selby.

Forticrete roofing products

Forticrete's ability to replicate natural materials cost-effectively extends to a range of the most established and the most innovative roof tiles and slates. Products that replicate the appeal of natural stone, slate, traditional plain tiles or pantiles but with many practical and environmental advantages. Used in conjunction with Walling and Cast Stone products, they provide a single-source solution to creating a home's complete external envelope.

Tel: 01525 244900 Fax: 01525 850432
E-mail: roofing@forticrete.com



Kiveton Natural Raked Battered Walling at Anstone, Kiveton Park, Sheffield.

Kiveton Walling™

Evoking the old-world charm of a mason-crafted wall, Kiveton Walling™ is a unique product that uses the colour range from Anstone® Walling and has been developed by Forticrete to provide free standing landscape or retaining walls. It is designed for use on small landscaping or large civil engineering projects and is available in a range of colours and face finishes that match many of the regional stone variations prevalent throughout the UK.

Tel: 01909 775000 Fax: 01909 775043
E-mail: walling@forticrete.com

Product samples



The colours reproduced within this brochure are as accurate as the photographic and printing processes will allow. Where colour matching is critical, you are advised to view actual product samples.

These are readily available via our Anstone office by calling **01909 775000** or the sample request area of our website – **www.forticrete.co.uk**

For larger projects, sample panels can be provided.

Cast Stone enquiries:

Forticrete Limited,
Anstone, Kiveton Park Station, Kiveton Park,
Sheffield S26 6NP

Tel: 01909 775000

Fax: 01909 773549

E-mail: caststone@forticrete.com

Information on the complete range of Forticrete products can be found on the Internet at **www.forticrete.co.uk**

Forticrete, Shearstone, Hardrow, Duets, Ecowall, the Plus device and the E device are registered trademarks of Forticrete Ltd.

CRH is a registered trademark of CRH plc.

The 'F' Logo, Cast Stone, Kiveton Walling, and Stone In Stock are trademarks of Forticrete Ltd.

Anstone and Caplock are registered trademarks of Ibstock Brick Ltd.

This document does not form part of any contract and Forticrete cannot accept liability for any errors or omissions.

In order to maintain its position as a market leader, Forticrete operates a policy of continuous product development and therefore reserves the right to alter specifications without notice.

Although the instructions contained in this publication and any other information published by Forticrete are believed to be accurate at the date of publication, they are strictly for guidance only and Forticrete accepts no liability in relation to their use or for any losses, howsoever caused. You are responsible for taking all reasonable steps to ensure your use of the goods/products conforms to all applicable health and safety requirements from time to time. If in doubt, please consult appropriately qualified persons. All products sold by Forticrete are sold subject to Forticrete's Terms and Conditions of Sale, a copy of which is available on request.

© Forticrete Ltd. 2011. All rights reserved.



Mixed Sources
Product group from well-managed forests, controlled sources and recycled wood or fibre
www.fsc.org Cert no. 11-COC-02619
©1996 Forest Stewardship Council

Forticrete® stone
Confidence you can build on