



CD Brick & Stone

Unit D2, Leigh Trading Estate,
Norweb Way, Butts Street,
Leigh, Lancs WN7 3AE
Tel 0161 797 2643 Fax 01942 609 596
www.cdbands.co.uk
E mail sales@cdbands.co.uk



New Price List
February 1st

2019

Forticrete stone

Architectural Cast Stone Products

Heads & Cills

While the following price list is for stock items from our yard in Leigh, we can also produce goods made to size, please enquire on delivery period. For further information, please contact the sales office on the above telephone number.

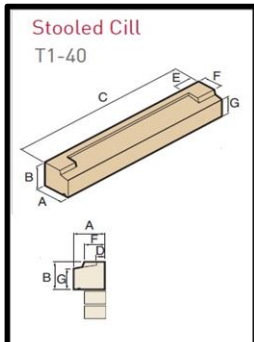

T1-40 Stooled Cills B=140mm x A=150mm x G=105mm E=102.5mm Stools					
460/665mm	485/693mm	572/778mm	630/835mm	685/890mm	797/1003mm
£46.18	£48.31	£54.03	£58.02	£61.78	£69.65
915/1120mm	1022/1228mm	1135/1340mm	1200/1405mm	1248/1453mm	
£77.79	£85.89	£93.04	£97.60	£100.89	
1342/1547mm	1360/1565mm	1472/1678mm	1585/1790mm	1770/1975mm	
£107.44	£108.68	£116.73 *	£124.30 *	£137.15 *	
1810/ 2015mm	2035/2240mm	2260/2465mm	2339/2544mm	2889/3094mm	
£139.92 *	£155.54 *	£171.18 *	£176.66 *	£214.85 *	

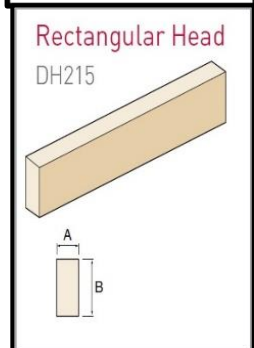

DH215 Heads B=215 x A=100mm *** these are not loadbearing ***					* = 2 piece	
693	835	985	1000	1120	1150	
£54.10	£65.21	£76.87	£78.07	£87.43	£89.73	
1269	1391	1405	1547	1675	1975	
£99.04	£108.20 *	£109.68	£120.74	£130.42 *	£154.19 *	
2015	2245	2305	2544	2815	3099	
£156.56*	£174.86 *	£179.97 *	£198.56 *	£219.36 *	£241.48 *	
1975 (1piece)	2544 (1 piece)	3955	5093			
£169.61	£218.42	£339.22*	£436.84 *			

Stooled cills are built in at the time of construction. They should be bedded under the stooing only at the time of installation with an inert packer in the centre. The cill should be solidly pointed as the scaffold is taken down upon completion of the construction.

DH140 Heads	985	1120	1269	1405	1547	1975 *	2245 *	2544 *	2815 *	3099 *
140mm x 100mm	£51.21	£58.26	£66.01	£73.11	£80.46	£102.78	£116.32	£132.77	£146.22	£160.92

T1 Stooled one end Cills R/H or L/H 140mm x150mm	836	892	985	1005	1117	1230	1267	1544
	£63.82	£67.96	£75.30	£76.62	£85.33	£93.82	£96.94	£117.96

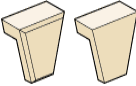



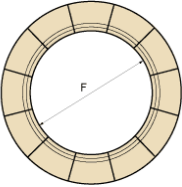
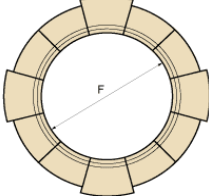
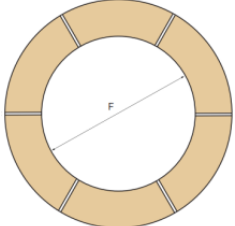

 Clip on Keystones	K1 Plain for 140mm Head	K2 Plain for 215mm Head	CK2 Chamfered for 215mm Head
	£31.59	£46.46	£46.46

T11 Slip Cill 140mm x 150mm 105mm front  1115mm 1500mm	T11 Slip Cill Corner 140mm x 150mm  45deg 236 x 236mm 90deg 265 x 265mm	T11-40-90EXT T11-40-135EXT @ £77.52 each @ £104.30 each	@ £47.23 each @ £47.23 each
---	--	--	--

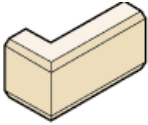
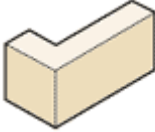
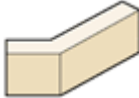
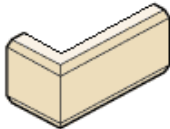
Bull's-eye Window Surrounds

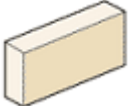
BU1 Plain 140mm x 140mm x105mm x 75mm x 600mm  @ £278.92 each	BU2 Keystone 140mm x 140mm x105mm x 75mm x 30mm x 600mm  @ £297.50 each	BU3 Plain 100 x 215 x 915 @ £468.30  BU4 Plain 100 x 215 x 1200 @ £598.48
--	--	--

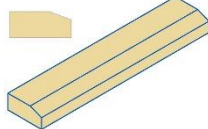
Quoins, Ashlars Etc.

Q11 Chamfered Quoin 118mm x 215mm x 348mm x 233mm x 18mm  @ £24.96 each	Q2 Plain Quoin 100mm x 215mm x 330mm x 215mm  @ £21.72each	Q6 45deg Plain Quoin 100mm x 215mm x 480 mm x 250mm x 45deg  @ £56.47 each	Q60 Renovation Quoins 330/215 x 215 x 50mm  @ £20.85 each
JU2 Jamb / Mullions 102.5 x 100 no fixings  1190mm @ £62.47 1490mm @ £78.24	A1 Ashlar Block 100mm x 215mm x 440mm  @ £12.03 each	BatBox or SwiftBox  440 x 215 x 100mm £149.46 Does not include bat or swift motif	Wet Cast Threshold Cills 150/100 x 75/50  900mm @ £41.74 1200mm @ £55.66
Repair Kits Small tub @ £9.36 each Medium tub @ £25.36 each	Easipoint Historic Pointing Mortar 12.5 kg @ £137.60 each	2 Part Epoxy Resin Adhesive for Renovation Quoins = about 6 - 8 quoins @ £40.30	20 kg Multiflex  For stick on Quoins = about 20 quoins £51.81

Renovation/Stick on Quoins



These quoins are increasingly being seen as a simple means of improving the aesthetic appeal to the exterior of even the most ordinary property.

The 50mm (35mm on bed) two part quoins are compression moulded, with the same components to match our range of stone products, produced in the traditional wooden mould then hand finished.

All prices are exclusive of VAT



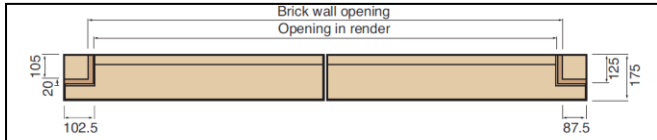



T4 – 40 Stooled Render Cills 175 x 140 (usually available in 7-10 Days)

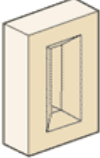
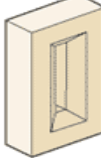

* Opening reduced by 30mm to allow render finish into brickwork reveals.

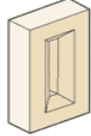
488 / 663mm	@	£53.56
630 / 805mm	@	£64.99
915 / 1090mm	@	£88.01
1200 / 1375mm	@	£111.00
1342 / 1522mm	@	£122.91
1770 / 1945mm	@	£157.03 2 pc
2339 / 2514mm	@	£202.90 2 pc

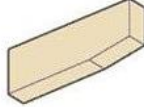
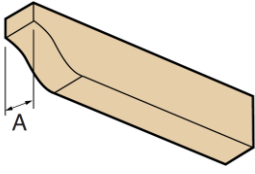
Gable Vents, Datestones & Corbels

<p>GV1 Gable Vent 590mm x 327mm x 120mm x 50mm</p>  <p>@ £135.71 each</p>	<p>GF1 False Gable Vent 590mm x 327mm x 120mm x 50mm</p>  <p>£108.22 each</p>	<p>GV2 Gable Vent 740mm x 215mm x 120mm x 45mm</p>  <p>@ £107.87 each</p>	<p>SGV1 Small Gable Vent 365mm x 215mm x 100mm</p>  <p>@ £45.43 each</p>
<p>NS2 Datestone 290mm x 440mm x 100mm</p>  <p>@ £159.87 each</p>	<p>C4 Corbel 100mm x 215mm x 180mm x 665mm x 445mm</p>  <p>@ £59.54 each</p>	<p>C8 Ogee Corbel 665 x 100 x 140</p>  <p>£37.22 each</p>	<p>NS1 Datestone 365mm x 550mm 100mm</p>  <p>@ £251.02 each</p>



Datestone only (namestones price on application)

Non-Stock Forticrete Cast Stone

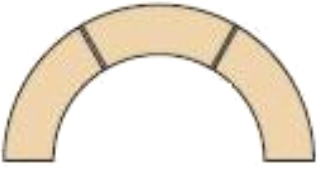
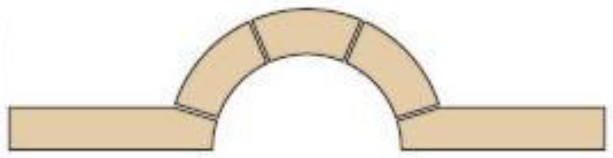

Delivery 1-6 weeks from order

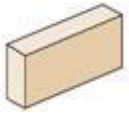
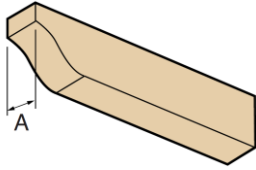
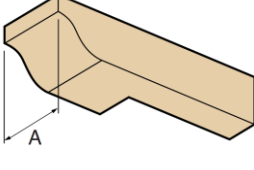
Window Opening Sizes	DH1 Plain Head: o/a 140 x 100	DH11 Splayed Heads 215 x 100
488	693 £36.09	£39.38
630	835 £43.47	£51.56
915	1120 £58.26	£74.85
1200	1405 £73.11	£98.20
1342	1547 £80.46	£109.83
1770	1975 £102.78 2 pc	£144.80
1800	2005 £104.30 2 pc	
2100	2305 £119.87 2 pc	
2339	2544 £132.37 2 pc	£191.48
SH2 Structural Heads 215 x 100 Usually 10-12 weeks from order	T11-40 Slip Cills o/a 140 x 150mm	TC1 Traditional Stooled Cill
1120 @ £206.95	478 £33.21	488/693 £48.13
1405 @ £259.62	620 £43.15	630/835 £58.02
1547 @ £285.85	905 £62.95	915/1120 £77.79
1975 @ £364.94	1190 £82.70	1200/1405 £97.60
2005 @ £370.48	1332 £92.59	1342/1547 £116.21
2305 @ £425.92	1760 £122.36 *	1770/1975 £137.15
	2329 £161.94 *	2339/2544 £176.66

<p>AH1 Arch Surround 3 piece 915mm Int Dia 215 x 100 @ £234.15</p>  <p>AH2 Arch Surround 3 Piece 1200mm Int Dia 215 x 100 @ £299.24</p>	<p>AH3 Arch Surround 5 Piece 2950 / 915 x 100 x 215 @ £437.34</p>  <p>AH4 Arch Surround 5 Piece 3805 / 1200 x 100 x 215 @ £496.24</p>
--	---

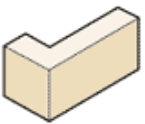
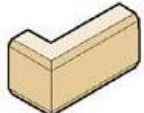
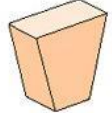
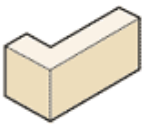
<p>A3 Ashlar Blocks 440 x 150 x 215 £28.95</p> 	<p>C8 Ogee Corbel 665 x 100 x 140 £37.22</p> 	<p>C9LorR Ogee Corbel 665 x 215 x 140 £63.22</p> 	<p>Wet Cast Threshold Cills 150/100 x 75/50 900mm @ £42.15 1200mm @ £55.66</p> 
---	---	--	---

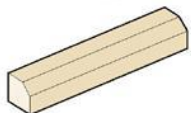
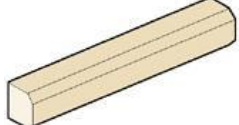
<p>Q5 Plain Quoin 440/215 x 100 x 215 £25.86</p> 	<p>RQ11 Chamfered Render Quoin 373/263 x 143 x 215 £34.93</p> 	<p>K5 Keystone 305/150 x 165 x 290 £37.22</p> 	<p>Q3 Plain Quoin 440/215 x 100 x 290 £58.94</p> 
---	--	---	---

<p>PL1 Plinth 890 x 150 x 140</p>  <p>PL1 Plinth £66.93 PL1-90 Ext Angle £26.98 PL1-90 Int Angle £26.98 PL1 135 Ext Angle £30.66 PL1-135 Int Angle £30.66</p>	<p>SC1 String Course 890 x 130 x 140</p>  <p>SC1 String £66.93 SC1-90 Ext Angle £26.98 SC1-90 Int Angle £26.98 SC1-135 Ext Angle £30.66 SC1-135 Int Angle £30.66</p>	<p>SC3-40 String Course 890 x 150 x 140</p>  <p>SC3 String £69.97 SC3-90 Ext Angle £38.16 SC3-90 Int Angle £38.16 SC3-135 Ext Angle £41.82 SC3-135 Int Angle £41.82</p>
---	--	---

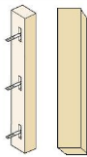
<p>JU2 100 x 102.5 Jambs</p> <p>740mm £38.86 1040mm £54.55 1340mm £70.37 2090mm £109.70 2 Pc</p>		<p>890mm £46.73 1190mm £62.47 1490mm £78.24</p>
---	---	---

<p>Caplock Coping</p>  <p>DCC-305 890 x 305 x 103mm @ £130.08</p> <p>TWC-305 890 x 305 x 153mm @ £130.08</p>	<p>MTW Coping</p>  <p>MTW 405 Coping 440 x 405 x 108 @ £79.21</p> <p>MTW 405 Stop End @ £79.21</p> <p>MTW 405 Universal Return @ £84.52</p> <p>MTW 470 Coping 440x470x108 @ £91.64</p> <p>MTW 470 Stop End @ £91.64</p> <p>MTW 470 Universal Return @ £115.88</p>
--	--

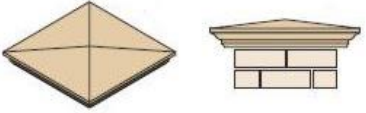
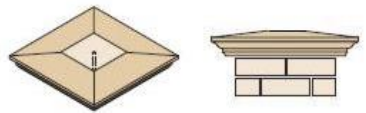
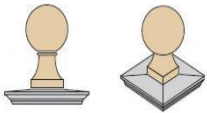
<p>MPC1 Pier Cap 2 ½ brick 740 x 740 x 108 @ £202.82</p>  <p>MPC2 Pier Cap 2 brick 640 x 640 x 108 @ £171.43</p>	<p>MPD1 Dowelled Pier Cap 740 x 740 x 96 @ £202.82</p>  <p>MPD2 Dowelled Pier Cap 640 x 640 x 96mm @ £171.43</p>	<p>Finial Set inc S4 Sphere 664 h x 365sp x 300b @ £304.24</p>  <p>Finial Set inc S5 Sphere 529h x 288sp x 215b @ £155.56</p>
---	---	--

LABEL MOULD (OPTION)

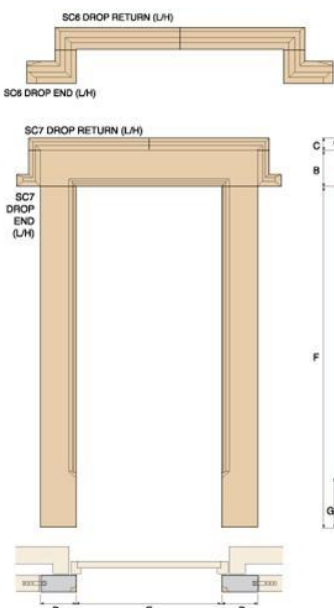

DOOR SURROUND DIMENSIONS & WEIGHTS							
Type Ref.	A	B	C	D	E	F	G Weight (Ln metre)
DS1 w	100	215	70	215	1025	2095	300 43
DS2	100	215	70	215	1800	2095	300 43
DS3	100	215	70	215	2400	2095	300 43
SC6	158	-	140	-	-	-	- 38
SC7	140	-	70	-	-	-	- 18

- DS1 @ £743.70 each
- DS2 @ £836.59 each
- DS3 @ £929.58 each

- SC6 @ £66.91 each
- SC6 Dropper @ £47.52 each

- SC7 @ £37.12 each
- SC7 Dropper @ £26.53 each

PSH1 Head @ £1115.59 each
 PSH3 Head @ £1189.82 each

PJ1 Jamb @ £126.11 each
 PJ2 Jamb @ £90.13 each
 PJ3 Jamb @ £108.25 each

SC6 @ £67.01 each
 SC6 Dropper @ £47.54 each

SC7 @ £37.12 each
 SC7 Dropper @ £26.53 each

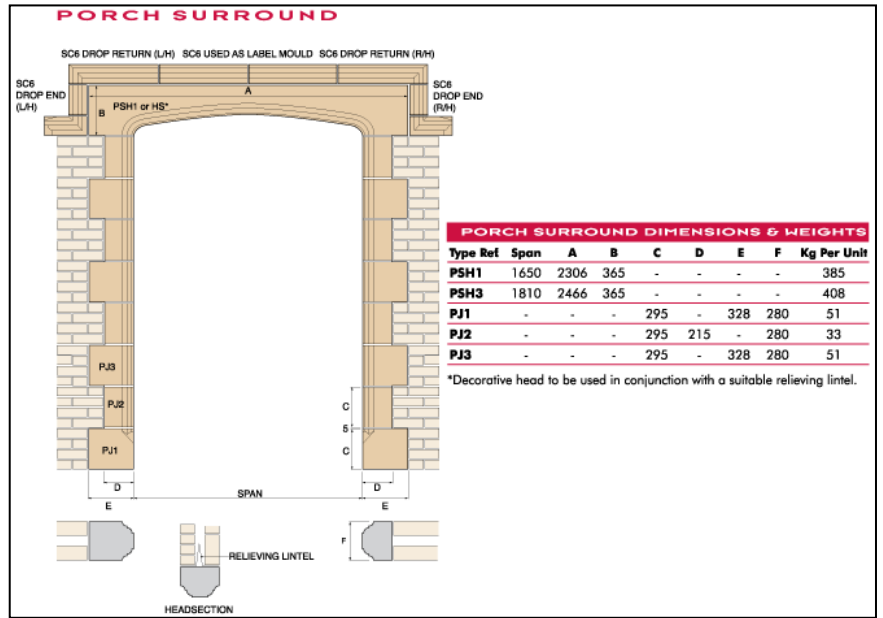

PORCH SURROUND DIMENSIONS & WEIGHTS

Type Ref	Span	A	B	C	D	E	F	Kg Per Unit
PSH1	1650	2306	365	-	-	-	-	385
PSH3	1810	2466	365	-	-	-	-	408
PJ1	-	-	-	295	-	328	280	51
PJ2	-	-	-	295	215	-	280	33
PJ3	-	-	-	295	-	328	280	51

*Decorative head to be used in conjunction with a suitable relieving lintel.

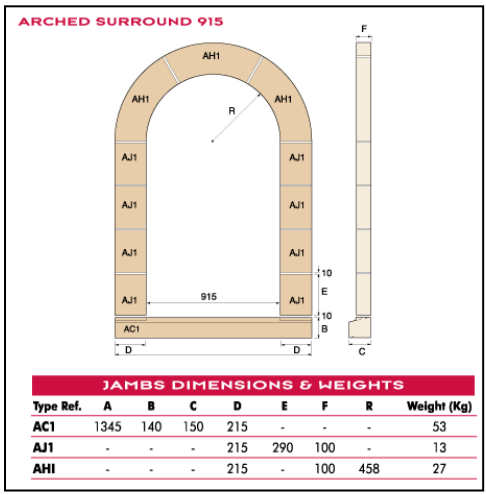

JAMBS DIMENSIONS & WEIGHTS

Type Ref.	A	B	C	D	E	F	R	Weight (Kg)
AC1	1345	140	150	215	-	-	-	53
AJ1	-	-	-	215	290	100	-	13
AH1	-	-	-	215	-	100	458	27

AC1-915 @ £93.62 each
 AC4-1200 @ £111.53 each
 AJ1 @ £30.00 each

AH1-915 * @ £234.20 each
 AH2-1200* @ £297.49 each
 *3 parts

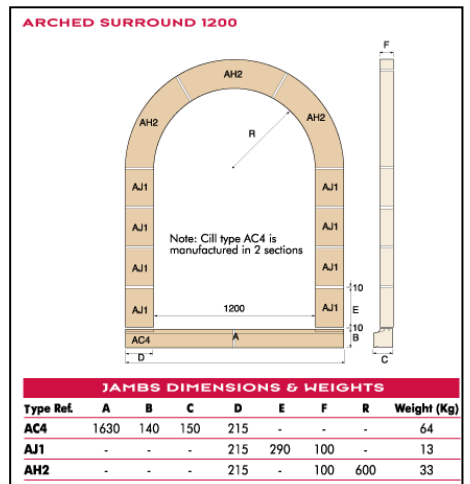

JAMBS DIMENSIONS & WEIGHTS

Type Ref.	A	B	C	D	E	F	R	Weight (Kg)
AC4	1630	140	150	215	-	-	-	64
AJ1	-	-	-	215	290	100	-	13
AH2	-	-	-	215	-	100	600	33

Retro Cills for instalation after brickwork finished

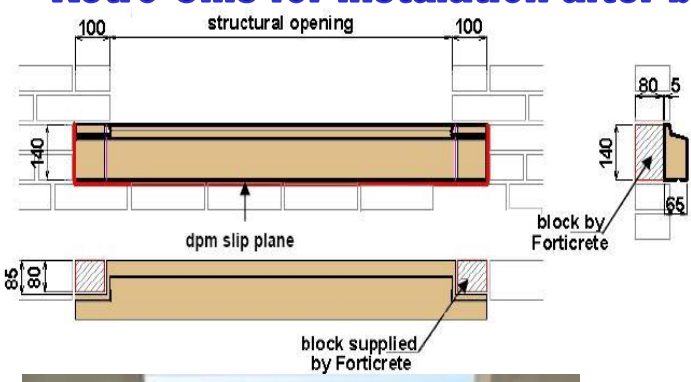

(3-5 Weeks Delivery)

RFT1 Cill 140mm deep	
488/693mm	£48.13
630/835mm	£58.02
915/1120mm	£77.79
1200/1405mm	£97.60
1342/1547mm	£116.21
• 1770/1975mm	£137.15
• 2339/2544mm	£176.66
• = 2 piece	

RFT4 Cill for Render	140mm deep
488/458/663mm	£53.56
630/600/805mm	£64.98
915/885/1090mm	£88.00
1200/1170/1375mm	£111.00
• 1347/1317/1522mm	£122.91
• 1770/1740/1946mm	£157.31
• 2339/2309/2514mm	£202.99
• = 2 piece	

All prices are exclusive of VAT

*** Pier Caps, Finials & Copings

Caps & Copings in Stock

FORTICRETE Caps

Apex Pier Caps			Dowelled Pier Caps		
PC11	375mm x 75/50mm Apex	£28.77	PD7	375mm x 75/50mm Dowelled	£28.77
PC13	525mm x 75/50mm Apex	£64.01	PD8	525mm x 75/50mm Dowelled	£64.01
Pier Caps Below please enquire for delivery period					
PC1	315mm x 125/75mm Apex	£39.06	PD1	315mm x 106/75mm Dowelled	£40.93
PC2	425mm x 125/75mm Apex	£70.64	PD2	425mm x 111/75mm Dowelled	£74.36
PC3	540mm x 140/75mm Apex	£120.84	PD3	540mm x 122/75mm Dowelled	£130.20

Chatsworth Pier Caps			Blenheim Pier Cap		
CDPC11	340/467 x 175mm	£102.03	CDPC6	328/460 x 100mm	£79.33
CDPC8	450/577 x 175mm	£130.46	CDPC7	440/570 x 100mm	£117.90

Spheres			Bases		
S1	228mm	£44.59	PB3 Base	440/520 x 70mm	£91.04
S2	305mm	£92.94	PB4 Base	552/632 x 70mm	£133.81
S3	380mm	£178.58	PB5 Base	665/745 x 70mm	£180.14

FORTICRETE Copings

Flat Copings			Once Weathered Copings		
FC315-600	600 x 315 x 50mm	£28.60	OW315	890 x 315 x 75/50mm	£63.22
FC315	890 x 315 x 50mm	£52.09	OW400/600	600 x 400 x 75/50mm	£54.05
FC400	890 x 400 x 50mm	£63.95	OW400	890 x 400 x 75/50mm	£80.16
			OW400 UR	400 x 400 x 75/50 Universal Return	£59.15
Apex Copings					
TW200	890 x 200 x 75/50mm	£44.64	TW315	890 x 315 x 75/50mm	£63.20
TW305	890 x 305 x 75/50mm	£50.47	TW400	890 x 400 x 75/50mm	£80.16

NON STANDARD CAPS & COPINGS (please enquire for delivery period)



Forticrete Apex Pier Caps			Forticrete Dowelled Pier Caps		
PC4	650mm x 140/75mm	£174.74	PD4	650mm x 125/75mm	£182.40
PC5	765mm x 140/75mm	£241.68	PD5	765mm x 140/75mm	£252.58
PC10	300mm x 100/50mm	£25.54	PD6	300mm x 100/50mm	£25.54
PC12	375mm x 110/60mm	£39.75	PD9	525mm x 100/50mm	£89.34
PC14	525mm x 100/50mm	£89.34	PD10	610mm x 75/50mm	£88.28
PC15	525mm x 150/100mm	£127.24			
PC16	610mm x 75/50mm	£88.28			
PC17	750mm x 200/50mm	£195.06			

Charsworth Pier Caps			Blenheim Pier Caps		
CDPC12	215/362 x 175mm	£93.04	CDPC6	328/460 x 100mm	£79.33
CDPC11	340/467 x 175mm	£102.03	CDPC7	440/570 x 100mm	£117.90
CDPC8	450/577 x 175mm	£130.46			
CDPC9	560/687 x 175mm	£190.78			
CDPC10	673/800 x 175mm	£254.35			

Finial (2 piece)		
SF2/300		POA
SF3/380		POA

CDC5, CDOW, MC1, CDF6, CDC7			CDCP6, CDCP7, CDCP8		
CDC5	375 x 600 x 75/50 Apex	£42.12	CDCP6	320 x 135 x 600mm	£62.06
CDOW	305mm x 600 x 75/50 O/W	£36.74	CDCP7	325 x 150 x 600mm	£74.49
MC1	300/372 x 122 x 600mm	£90.86	CDCP8	300 x 150 x 600mm	£54.27
CDF6	450 x 50 x 600mm Flat	£40.42			
CDC7	315mm x 600 x 50 Flat	£36.74			

Fylde Range (Non-Stock, availability on request)



Acorn  360mm High £120.59	Imperial Sphere 		Pineapple  400mm £216.87	Sphere 	
	11" £82.62 12" £117.06 15" £216.87	4" £34.41 8" £75.73 12" £110.16 15" £216.87			



Fluted Pier Cap 	225 x 225 £75.73	260 x 300 £90.59	330 x 330 £86.16	335 x 670 £155.74	340 x 440 £147.08
	340 x 600 £156.06	360 x 360 £110.74	450 x 450 £135.99	450 x 225 £110.84	500 x 500 £155.34
	575 x 575 £189.33	675 x 675 £287.45	700 x 700 £379.78	950 x 950 £626.52	



Chamfered Pier Cap 	280 x 280 £68.85	400 x 400 £84.35	410 x 510 £89.51	450 x 450 £89.51	530 x 290 £70.11
	530 x 530 £98.12	600 x 600 £120.48	680 x 680 £160.80	760 x 760 £265.85	830 x 830 £373.65

Deep Standard Caps 	330sq x 170 £107.45	385sq x 145 £111.18	400sq x 200 £129.96	470sq x 175 £132.96
	480sq x 200 £151.93	500sq x 300 £154.92	500 x 380x 145 £164.04	530sq x 350 £178.64
	530sq x 245 £172.65	570x460x175 £163.66	580sq x 175 £185.01	680sq x 395 £163.92



Standard Caps 	280 x 280 £60.26	280 x 390 £68.85	520 x 400 £81.90	600 x 600 £103.27	610 x 510 £100.90
	640 x 640 £133.28	730 x 730 £208.24	750 x 750 £243.31	915 x 915 £205.98	

Dome Top Pier Cap 	265 x 265 £75.73	390 x 390 £103.27	460 x 350 £124.44	Ashwood Pier Cap 	225 x 225 £151.50	330 x 330 £224.58
	520 x 520 £131.63	550 x 550 £151.97	630 x 630 £185.89		450 x 450 £434.45	500 x 500 £479.40
	740 x 740 £223.35				560 x 560 £524.97	600 x 600 £733.95



Round Edge Pier Cap 	265 x 265 £68.20	Regency Pier Caps 	260 x 260 £103.27	Flat Top Capings 	280 x 280 £96.25
	400 x 400 £91.24		390 x 390 £154.19		400 x 400 £112.20
	530 x 530 £103.27		520 x 520 £240.97		530 x 530 £134.45
	600 x 600 £127.37		600 x 600 £292.61		600 x 600 £168.16

Lytham Pier Cap 	260 x 260 £75.73	375 x 375 £91.23	510 x 510 £137.69	Raised Pier Cap * 	280 x 280 £144.58	400 x 400 £185.84	450 x 450 £203.15
	580 x 580 £189.33	625 x 625 £241.95	580 x 510 480 x 700 580 x 480 £189.33		530 x 530 £251.16	600 x 600 £278.83	*Includes Sphere

Gladstone Pier Caps 	330 x 330 x 200 £158.43	450 x 450 x 200 £213.89	450 x 450 x 400 £388.15	460 x 350 x 200 £208.60
	480 x 480 x 300 £348.54	560 x 560 x 200 £264.05	1145 x 560 x 400 £638.99	

Dunkirk Pier Caps 	330 x 330 £177.65	Minster Cap 	330 x 330 £299.73
	450 x 450 £313.06		450 x 450 £518.88
	560 x 560 £445.19		



Sunken Ball Pier Caps 	400 x 400 £124.10	520 x 520 £215.20
---	----------------------	----------------------

Biscuit Course 	225 x 225mm £34.48	Base Columns 	560 x 560mm £171.55 each
	330 x 330mm £42.19		
	440 x 440mm £52.76		
	560 x 560mm £87.65		

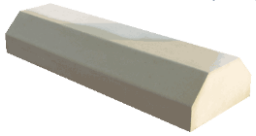
Apex Coping 	660x150x75/50 £31.68	900x150x75/50 £44.89	1000x200x75/50 £44.89	1000x250x75/50 £58.09
	1000x280x75/50 £65.56	1000x300x75/50 £76.57	1000x350x75/50 £81.96	1000x380x75/50 £98.34
	1000x400x75/50 £108.18	1000x450x75/50 £131.12	1000x560x150/50 £163.91	600x600x75/50 £98.34

Double Cant Coping 	910 x 150 x 70 £47.53	1000 x 230 x 150 £68.66	1000 x 285 x 100 £73.95	900 x 300 x 104 £83.23
	900 x 300 x 150 £108.26	1000 x 330 x 150 £116.18	1000 x 350 x 150 £118.83	900 x 400 x 150 £134.66
	1000 x 400 x 200 £139.94	900 x 430 x 230 £153.15	900 x 525 x 230 £171.64	

Half Round Coping 	204x215x100 £34.32	900x230x150 £76.57	Step Apex Coping 	600 x 300 x 250/50 £72.09	600 x 350 x 265/50 £95.79
	900x300x150 £99.03	900x360x150 £117.50		500 x 350 x 265/50 £87.13	600 x 500 x 250/100 £129.38
	1000x420x150 £145.23	1000x450x150 £155.79		600 x 500 x 290/50 £134.66	

Fluted Copings Pointed 	900 x 100 £110.90	800 x 280 £102.98	Fluted Copings Flat 	1000 x 235 £84.49	1000 x 290 £92.42
	1000 x 230 £100.34	1000 x 280 £99.03		1000 x 460 £109.58	1000 x 560 £118.61

Chamfered Copings 	1000 x 300 x 150 £101.07	Curved Coping with sides 	600 x 280 x 120 £55.45	900 x 300 x 150 £63.03
			1000 x 400 x 150 £87.13	1000 x 460 x 150 £102.98

CD Stone Wetmix Products

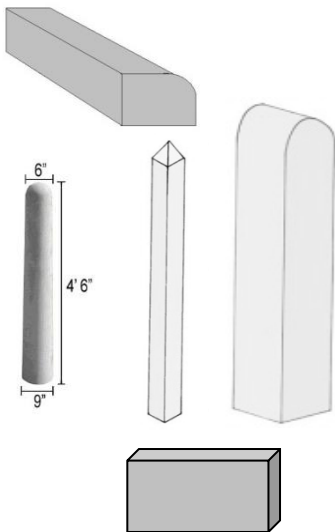
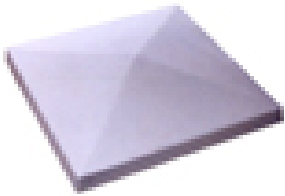

PATH EDGINGS	R/TOP	3' x 6"	900 x 150	£5.79
		3' x 6" Buff	900 x 150	£7.11
	F/TOP	3' x 6"	900 x 150	£5.79
	R/TOP	3' x 8"	900 x 200	£7.11
LINTELS				
Per Foot		6" x 4"	150 x 100	£4.73
		4" x 3"	100 x 75	£3.05
SADDLEBACK COPINGS				
		2' x 5"	610 x 127 x 38/26	£5.08
		2' x 5" Buff	610 x 127 x 38/26	£9.49
		3' x 7"	900 x 178 x 75/50	£13.53
		3' x 11"	900 x 279 x 75/50	£16.91
		3' x 11" Buff	900 x 279 x 75/50	£27.09
		3'3" x 12"	1000 x 300 x 75/50	£16.96
		3' x 14"	900 x 350 x 75/50	£25.39
		2' x 11"	610 x 279 x 50/26	£8.62
		2' x 11" Buff	610 x 279 x 50/26	£14.58
FLAT COPINGS				
		2' x 5"	610 x 127 x 38	£5.08
		3' x 7"	900 x 178 x 50	£11.17
		3' x 11"	900 x 279 x 50	£13.89
SPLAYED COPINGS				
		3' x 12"	900 x 300 x 75 x 50	£20.30
		3' x 14"	900 x 350 x 75 x 50	£25.39
PIER CAPS				
		9" x 9"	225 x 225	£5.08
		9" x 9" Buff	225 x 225	£11.85
		12" x 12"	300 x 300	£12.52
		12" x 12" Buff	300 x 300	£18.63
		15" x 15"	380 x 380	£16.91
		15" x 15" Buff	380 x 380	£25.39
		16" x 16"	400 x 400	£20.30
		16" x 16" Buff	400 x 400	£26.41
		18" x 18"	450 x 450	£26.41
		18" x 18" Buff	450 x 450	£40.63
		21" x 21"	530 x 530	£34.19
	21" x 21" Buff	530 x 530	£50.77	
DOOR STEPS				
		3' x 12" x 6"	900 x 300 x 150	£47.39
		3' 6" x 12" x 6"	1065 x 300 x 150	£54.16
		4' x 12" x 6"	1219 x 300 x 150	£60.93
DISH CHANNELS				
		3' x 9" x 4"	900 x 225 x 102	£20.30
GARDEN GATE POSTS				
		5' 6" x 5" x 5"	1676 x 127 x 127	£45.71
FARM GATE POSTS				
		7' x 8" x 8"	2133 x 202 x 203	£99.53
BOLLARDS				
		4' 6" x 9" to 6"	1371 x 225 to 150	£94.79
PADSTONES				
		440 x 215 x 100		£15.84
		440 x 215 x 140		£19.58



CD Stone Treads, Risers & Thresholds

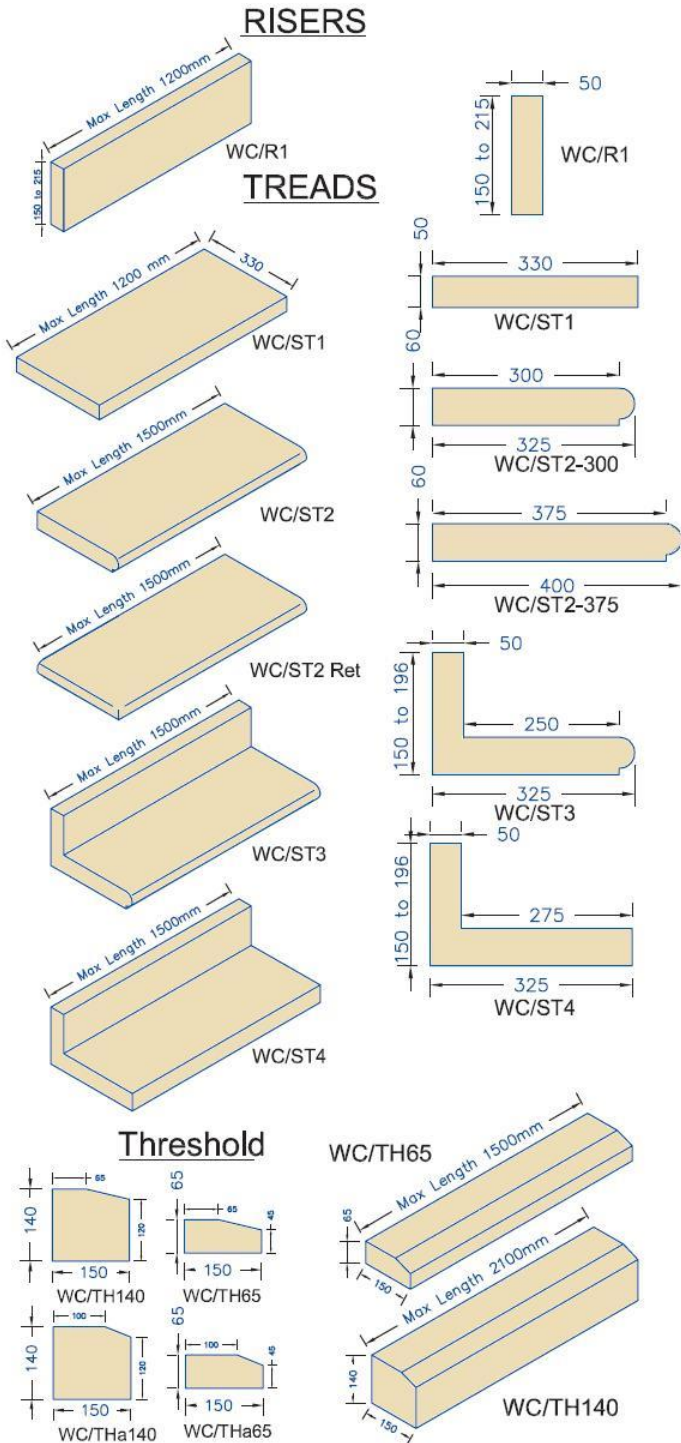

Wet Cast Stone Treads, Risers & Thresholds With max lengths	Price per Linear Metre
WC/R1 Plain Risers 50 x 150 max 1200mm 50 x 215 max 1200mm	£63.01 £90.37
WC/ST1 Plain Treads 50 x 330 max 1200mm	£69.31
WC/ST2 Bull Nosed Treads 60 x 325 max 1500mm 60 x 400 max 1500mm	£81.94 £100.88
Tread Return	+ £9.47/mtr
WC/ST3 Bull Nosed Treads & Risers 150mm Upstand 196mm Upstand 60 x 325mm max 1500mm	£99.17 £109.75
WC/ST4 Plain Treads & Risers 150mm Upstand 196mm Upstand 50 x 325 max 1500mm	£99.17 £109.75
WC/TH65 Threshold Cills 60 or 100mm Bar 65 x 150 max 1500	£81.94
WC/TH140 Threshold Cills 60 or 100mm Bar 140 x 150 max 2100	£88.27

Columns & Balustrades

Forticrete Standard Portico

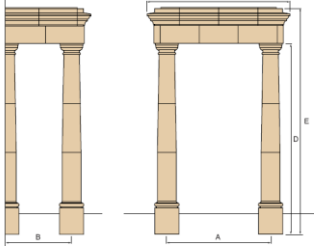
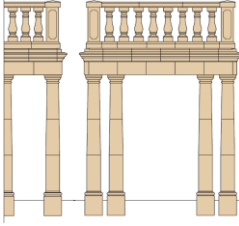
 <p>Kit 1W 1730 x 1735 x 2390 x 3180 x 3855 @ POA Kit 1W+HC 1730 x 1735 x 2390 x 3180 x 3855 (with half column) @ POA Kit 2W 2380 x 1735 x 3040 x 3180 x 3855 @ POA</p>	 <p>Kit 2W+HC 2380 x 1735 x 3040 x 3180 x 3855 (with half column) @ POA Kit 3W 3030 x 1735 x 3690 x 3180 x 3855 @ POA Kit 3W+HC 3030 x 1735 x 3690 x 3180 x 3855 (with half column) @ POA **Balustrade Prices on Application</p>
--	--

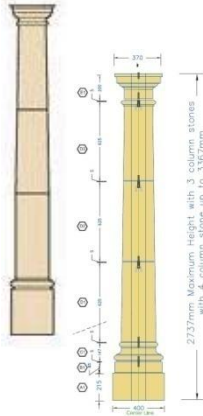
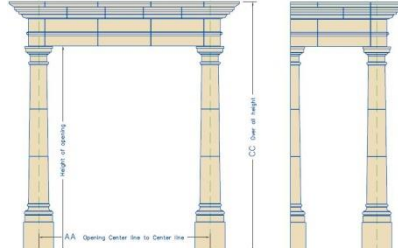
<p>Forticrete Columns Base (PO4.1), Pedestal (PO4.2), Columns (PO5.1 PO5.2 & PO5.3) & Capitol (PO3.1) @ £1217.26 Half Column @ POA</p> <p>CD STONE Columns Columns 2737 H (7 piece) A1 SQ BASE 400x215 mm / B1 RD BASE 85mm D1 SHAFT 625mm / D2 SHAFT 625mm / D3 SHAFT 625mm / E1 CAPITAL 370x200mm @ £1012.53 each</p> 	 <p>CD Stone Porticos Type 1 1730 F x 1085 S x 2895 H @ POA Type 2 2380 F x 1085 S x 2895 H @ POA Type 3 2530 F x 1085 S x 2895 H @ POA Type 4 3180 F x 1085 S x 2895 H @ POA</p>
--	--

Cast Stone Balustrades (4/6 weeks delivery on products below)

Forticrete Balustrade

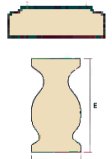
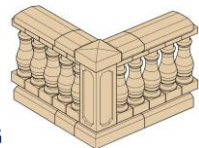
<p>BP1 Balusters 300 x 150mm @ POA BC1 Coping/Plinth 215 x 590 @ POA BC1S Coping Stop End @ POA</p> 	<p>PS28 DIE UNIT @ POA PS29 BALUSTER @ POA PS30 DIE CAPPING @ POA PS40 L/H PLINTH @ POA PS41 R/H PLINTH @ POA PS42 BALUSTER COPING @ POA PS43 BALUSTER PLINTH @ POA</p> 
---	---

CD Balustrade

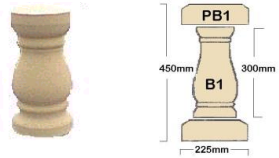
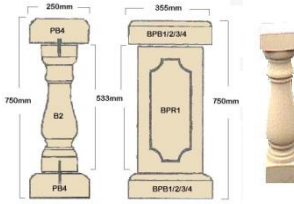
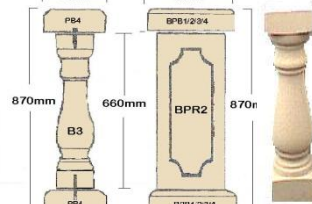
<p>B1 Balusters 300mm @ £ 22.78 each PB1 Coping 215mm x 590mm @ £28.77 each Stop End / Return Coping @ £37.45 each</p> 	<p>B2 Baluster 533mm @ £57.93 BPR1 Corner Die Unit @ £217.63</p> 	<p>B3 Baluster 660mm @ £74.08 BPR2 Corner Die Unit @ £251.62</p> 	<p>PB4 Coping 250 x 590mm @ £56.94 PB5 Stop End Coping @ £47.67 PB6 Coping Return @ £47.67 BPC1 Corner Cap @ £45.28 BPB1/2/3/4 Corner Plinth @ £40.83</p>
--	---	--	---

Brick Specials

<p>Apex Copings 210mm x 120/45mm x 65mm</p> 	<p>1-50 @ £3.59 each 51-500 @ £3.29 each</p>
<p>Half Round Coping 315mm x 155mm x 76mm</p> 	<p>1-50 @ £4.98 each 51 - 500 @ £4.58 each 501 + @ £4.08 each</p>
<p>Half Round Coping 220mm x 110mm x 65mm</p> 	<p>1-50 @ £3.59 each 51-500 @ £3.29 each</p>
<p>Half Round Coping 310mm x 160mm x 65mm</p> 	<p>1-50 @ £4.98 each 51 - 500 @ £4.58 each 501 + @ £4.08 each</p>
<p>Half Round Coping 233mm x 115mm x 145mm</p> 	<p>1-50 @ £9.59 each 51+ @ £8.59 each</p>
<p>Band Course 230 x 105 x 80mm Red Smooth</p> 	<p>1-50 @ £5.39 each 50 + @ £4.96 each</p>
<p>Band Course 215 x 160 x 100mm Blue Brindle</p> 	<p>1-50 @ £6.80 each 50+ @ £6.10 each</p>
<p>Coping 220 x 435 x 100mm Blue Brindle</p> 	<p>1 - 29 @ £12.86 each</p>

Blue Brindle Pier Caps (2 Piece) 300 x 375mm		<p>£34.79 Set</p>
Blue Brindle Pier Caps (4 Piece) 450 x 450mm		<p>£59.80 per set</p>
65mm Blue Brindle Single Cants AN5.1 Single Bullnose BN1.2 Plinth Stretcher PL3.2		<p>Price each 1-400 £1.48 400+ £0.98</p>
65mm Blue Brindle Plinth Stretcher Return PL7.2		<p>£1.98 each</p>
AN6.2 65mm Red Smooth Double Cants BN2.2 65mm Red Smooth Double Bullnose BN1.1 & BN1.2 65mm Red Smooth Single Bullnose AN 1.2 Red Smooth 65mm Squints AN5.2 Red Smooth 65mm Single Cant		<p>Price Each 1-100 £1.72 100-400 £1.52 400 + £1.32</p>
AN2.2 Red Smooth 65mm External Angles AN3.2 Red Smooth 65mm Internal Angles		<p>Price Each 1-50 £2.75 50 + £2.35</p>

Shearstone Walling



For sizes etc. please contact sales office.
Special Offer £19.97

Sq/mtr

Full Packs +£5 per sq/mtr For Part Packs

When they're gone, they're gone

Anstone Walling

Pitched face Anstone Walling Buff or Black Old Weathered			
Size 450 x 140mm	300 x 215mm	300 x 140mm	450 x 65mm
£45.57	£48.74	£45.57	£53.18
Split Anstone Walling Buff or Black Old Weathered			
Size 450 x 140mm	300 x 215mm	300 x 140mm	215 x 65mm
£39.08	£42.25	£39.08	£46.69

All above per m² supplied in full packs, if supplied in part packs + £3 per m²

Cottage Finish discontinued, only what is available from stock.



SPLIT

PITCHED